



---

## The Utah-400 Series 2

XL, 528, 288, 144 and 72 Systems



Setup and Operations Guide

---

---

---

---

## ***The Utah-400 Series 2 - Setup and Operations Guide***

- Document Number: 82101-0077
- Document Version: 2.5.4
- Date: September 14, 2016
- Printed in U.S.A.

### ***Copyrights and Trademarks***

© 2016 Utah Scientific, Inc., All rights reserved. Any use or reproduction of this guide's contents without the prior written consent of Utah Scientific, Inc. is strictly prohibited.

- Utah-400 is a trademark of Utah Scientific, Inc.
- Windows references (all versions) are registered trademarks of Microsoft Corporation.
- All other product names and any registered or unregistered trademarks mentioned in this guide are used for identification purposes only and remain the exclusive property of their respective owners.

### ***Notice***

Information contained in this guide is subject to change without notice or obligation. While every effort has been made to ensure that the information is accurate as of the publication date, Utah Scientific, Inc. assumes no liability for errors or omissions. In addition, Utah Scientific, Inc. assumes no responsibility for damages resulting from the use of this guide.

### ***FCC Compliance (USA) and Digital Equipment Compliance (Canada)***

This equipment has been tested and found to comply with the limits for a Class A, digital device, pursuant to Part 15, Subpart B of the FCC Rules and the Canadian EMC Requirement (ICES-003). These limits are designed to provide reasonable protection against harmful interference when the equipment is operated in a commercial environment. This equipment generates, uses, and can radiate radio frequency energy and, if not installed and used in accordance with the instruction manual, may cause harmful interference to radio communications. Operation of this equipment in a residential area is likely to cause harmful interference, in which case, the user will be required to correct the interference at their own expense. Shielded cables must be used to ensure compliance with the FCC Class A limits.

---

---

## ***Declaration of Conformity***

### **Utah Scientific, Inc.**

4750 Wiley Post Way, Suite 150  
Salt Lake City, Utah 84116-2878 U.S.A.

We declare our sole responsibility that the Utah-400 Digital Routing Switcher is in conformance with the following standards:

#### **Emission**

- EN55022:1994+A1&A2

#### **Immunity**

- EN55024:1998
- EN61000-3-2
- EN61000-3-3

#### **Safety**

- IEC 60950-1:2001 /EN 60950-1:2001

Following the provisions of the Directive(s) of the Council of the European Union:

- EMC Directive 89/336/EED
- Low Voltage Electrical Directive 72/23/EEC

Utah Scientific, Inc. hereby declares that the product specified above conforms to the above Directive(s) and Standard(s).



---

---

## ***Important Safeguards and Notices***

This section provides important safety guidelines for the Operator and Service Personnel. Specific warnings and cautions are found throughout the guide where they apply, but may not appear here. Please read and follow the important safety information, specifically those instructions related to risk of fire, electric shock, or injury to persons.

### **Safety Symbols**



- Hazardous Voltage symbol



- Caution symbol. The product is marked with this symbol when it is necessary to refer to the manual to prevent damage to the product.

### **Warnings**

Please observe the following important warnings:



- Any instructions in this guide that require opening the chassis, changing a power supply, or removing a board, should be performed by qualified personnel only. To reduce the risk of electric shock, do not perform any service unless you are qualified to do so.
- Heed all warnings on the unit and in the operating instructions.
- Do not use this product in or near water. Disconnect AC power before installing any options or servicing the unit unless instructed to do so by this manual.
- This product is grounded through the power cord ground conductor. To avoid electric shock, plug the power cord into a properly wired receptacle before connecting the product inputs or outputs.
- Route power cords and other cables so they won't be damaged.
- The AC receptacle (socket) should be located near the equipment and be easily accessible.
- Disconnect power before cleaning. Do not use any liquid or aerosol cleaner - use only a damp cloth.



- Dangerous voltages exist at several points in this product. To avoid personal injury, do not touch exposed conductors and components while power is on. Do not insert anything into either of the systems two-power supply cavities with power connected.
- Do not wear hand jewelry or watches when troubleshooting high current circuits, such as power supplies. During installation, do not use the door handles or front panels to lift the equipment as they may open abruptly and injure you.
- To avoid fire hazard when replacing fuses, use only the specified correct type, voltage and current rating as referenced in the appropriate parts list for this product. Always refer fuse replacement to qualified service personnel.
- Have qualified personnel perform safety checks after any service.

#### **Cautions**

Please observe the following important cautions:



- When installing this equipment do not install power cords to building surfaces. To prevent damage when replacing fuses, locate and correct the problem that caused the fuse to blow, before reconnecting power.
- Use only specified replacement parts

#### **Notices**

Please observe the following important notes:



- When the adjacent symbol is indicated on the chassis, please refer to the manual for additional information.
- For the HD-2020 Chassis and Master Control Panel, refer to “Connecting and Disconnecting Power” - Chapter 2 (Hardware Installation).

---

---

## *Company Information*

### **Utah Scientific, Incorporated**

**4750 Wiley Post Way, Suite 150  
Salt Lake City, Utah 84116-2878 U.S.A.**

- Telephone: +1 (801) 575-8801
- FAX: +1 (801) 537-3098
- Technical Services (voice): +1 (800) 447-7204
- Technical Services (FAX): +1 (801) 537-3069
- E-Mail -General Information: [info@utsci.com](mailto:info@utsci.com)
- E-Mail -Technical Services: [service@utsci.com](mailto:service@utsci.com)
- World Wide Web: <http://www.utahscientific.com>
- **After Hours Emergency:** +1 (800) 447-7204. Follow the menu instructions for Emergency Service.

---

---

## ***Warranty Policies***

### **Hardware Warranty**

Utah Scientific, Inc. warrants to the original purchaser that the Utah Scientific hardware is free from defects in materials and workmanship and will perform substantially in accordance with the accompanying written materials under normal use and service for a period of ten (10) years from the date of shipment. Any implied warranties on hardware are limited to ten (10) years. Some states/jurisdictions do not allow limitations on duration of an implied warranty, so the above limitation may not apply to certain specific purchasers.

### **Software Warranty**

Utah Scientific warrants that the software will perform substantially in accordance with the accompanying written materials for a period of one (1) year from the date of shipment.

### **Customer Remedies**

For the first one (1) year after purchase of the software and the first ten (10) years after the date of purchase of the hardware, Utah Scientific's and its suppliers' entire liability and purchaser's exclusive remedy shall be, at Utah Scientific's option, either:

- Return of the price paid, or
- Repair or replacement of the software or hardware that does not meet the above warranties and is returned to Utah Scientific under the returned materials authorization (RMA) process with freight and forwarding charges paid.

After the initial warranty periods, purchaser's exclusive remedy is the repair or replacement of the hardware upon payment of a fixed fee to cover handling and service costs based on Utah Scientific's then-current price schedule. The above warranties are void if failure of the software or hardware has resulted from an accident, abuse, or misapplication. Any replacement software or hardware will be warranted for the remainder of the original warranty period or thirty (30) days, whichever is longer.

***No other warranties.*** To the maximum extent permitted by applicable law, Utah Scientific and its suppliers disclaim all other warranties, either express or implied, including, but not limited to implied warranties of merchantability and fitness for a particular purpose, with regard to the software, the accompanying written materials, and any accompanying hardware. This limited warranty gives the purchaser specific legal rights. These rights may vary in certain states/jurisdictions.

***No liability for consequential damages.*** To the maximum extent permitted by applicable law, in no event shall Utah Scientific or its suppliers be liable for any damages whatsoever (including without limitation, damages for loss of business profits, business interruption, loss of business information, or any other pecuniary loss) arising out of the use of or inability to use

---

---

Utah Scientific products, even if Utah Scientific has been advised of the possibility of such damages. Because some states/jurisdictions do not allow the exclusion or limitation of liability for consequential or incidental damages, the above limitation may not apply in those circumstances.



---

Table of Contents

**CHAPTER 1**

*Introduction*

Conventions **1-3**  
Abbreviations **1-4**  
Terms **1-5**  
Routing Switcher Basics **1-6**  
    Switching Matrix **1-7**  
    Signal Levels **1-8**  
    The Utah-400 Routing Matrix **1-9**  
Component Locations **1-12**  
    XL Configuration **1-12**  
    528 Configuration **1-14**  
    288 Configuration **1-16**  
    144 Configuration **1-18**  
    72x72 Configuration **1-19**  
UT-400 Embedded Signal Processing Functionality **1-20**  
    TDM Enabled IO Cards **1-22**  
    Supported Signal Types **1-22**  
    Delay Considerations **1-22**  
    Shuffling versus Routing **1-23**

**CHAPTER 2**

*Hardware Installation*

In This Chapter **2-1**  
Unpacking and Inspection **2-2**  
    528 Systems **2-2**  
    XL Systems Carton Handling and Chassis Management **2-4**  
    Transferring an XL system between Equipment Racks **2-11**  
Installing Physical Equipment - 528 and XL Systems **2-16**  
Mounting Equipment in Rack Frames - 528 Systems **2-17**  
    Installing the Utah-400 Digital Routing Switcher **2-17**  
Installing the MX-Bus Cables **2-21**  
    Interconnecting the SC-4 and Utah-400 Frames **2-22**  
    Connecting the AES Reference Signal **2-24**  
    Determining and Setting Router Signal Levels **2-25**

---

---

Offset Switch	2-27
Serial Port	2-28
Ethernet Port	2-29
GPIO Port	2-30
Installing the Video/Unbalanced Digital Audio Input & Output	2-31
Installing the Analog Audio Input and Output Cables	2-33
Connecting and Disconnecting Power	2-34
DC Connectivity	2-36
Pre Power-Up Checks	2-37
UTAH-400 Series 2 - 72x72 AV Router	2-40
Overview	2-40
Rear Panel Interconnect	2-41
Hardware Checkout	2-42

## **CHAPTER 3**

### *Configuration and Operation*

In This Chapter	3-1
Utah 400 SC-4 Control	3-2
Chassis Types	3-4
72x72 Front and Rear Views	3-4
System Control Functionality	5
144 Front and Rear Views	3-6
288 Front and Rear Views	3-7
528 Module Array	3-8
Operation	3-10
Alarm Indication	3-10
Ethernet and RS-232 Connection	3-11
Crosspoint Cards Maintenance	3-11
Input and Output Card Removal and Replacement	3-12
Crosspoint Card Removal and Replacement	3-12
Air Dam Removal and Maintenance	3-13
Fan Service	3-14
Power Supply	3-15

## **CHAPTER 4**

### *Utah-400 Components*

In This Chapter	4-1
-----------------	-----

---

**Table of Contents**

---

Video Input	<b>4-3</b>
Multi-rate	<b>4-3</b>
Video Output Boards	<b>4-5</b>
Multi-rate	<b>4-5</b>
Multirate Fiber Input Card - 121234-1	<b>4-7</b>
Multirate Differential Pair Output Card – 121235-1	<b>4-9</b>
Fiber Interface - (Optional)	<b>4-11</b>
Specification Detail	<b>4-12</b>
Frame Controller	<b>4-13</b>
Overview	<b>4-13</b>
Monitor Matrix Module	<b>4-15</b>
Overview	<b>4-15</b>
Circuit Description	<b>4-15</b>
Controls and Indicators	<b>4-16</b>
Indicators.	<b>4-16</b>
Video Crosspoint Board	<b>4-17</b>
Overview	<b>4-17</b>
Circuit Description	<b>4-18</b>
Controls and Indicators	<b>4-18</b>
Crosspoint LEDs (Active)	19
UT400 288x288 Crosspoint Card – 121248-1	<b>4-20</b>
General	<b>4-20</b>
Circuit Description	<b>4-20</b>
Controls and Indicators	<b>4-21</b>
UT400 144x144 Crosspoint Card – 121242-1	<b>4-23</b>
General	<b>4-23</b>
Circuit Description	<b>4-23</b>
Controls and Indicators	<b>4-24</b>
UT400 Series 2 Dis-Embedding SDI Fiber Input Card – PN 121406-1	<b>4-26</b>
General	<b>4-26</b>
Circuit Description	<b>4-27</b>
Power Supplies	<b>4-27</b>
Controls And Indicators	<b>4-27</b>
Specifications	<b>4-28</b>
Rear Panel Connections	<b>4-29</b>
UT400 Series 2 Dis-Embedding SDI Input Card – PN 121292-1	<b>4-30</b>
General	<b>4-30</b>
Circuit Description	<b>4-31</b>

---

---

Power Supplies	<b>4-31</b>
Controls And Indicators	<b>4-32</b>
Specifications	<b>4-32</b>
Rear Panel Connections	<b>4-33</b>
UT400 Series 2 Embedding SDI Output Card – 121293-1/2	<b>4-34</b>
General	<b>4-34</b>
Circuit Description	<b>4-35</b>
Control	<b>4-35</b>
Power Supplies	<b>4-36</b>
Controls And Indicators	<b>4-36</b>
Specifications	<b>4-37</b>
Rear Panel Connections	<b>4-38</b>
UT400 Series 2 Embedding SDI Fiber Output Card – 121405-1	<b>4-39</b>
General	<b>4-39</b>
Circuit Description	<b>4-40</b>
Control	<b>4-40</b>
Power Supplies	<b>4-41</b>
Controls And Indicators	<b>4-41</b>
Specifications	<b>4-42</b>
Rear Panel Connections	<b>4-43</b>
UT400 Series 2 Triple Port MADI IO Card – 121320-1/2	<b>4-44</b>
General	<b>4-44</b>
Circuit Description	<b>4-44</b>
Controls And Indicators	<b>4-45</b>
Specifications	<b>4-47</b>
Rear Panel Connections	<b>4-47</b>
Serial Diagnostic Port Commands	<b>4-48</b>
UT400 Series 2 12 Port TDM Crosspoint Submodule – 121295-1	<b>4-49</b>
General	<b>4-49</b>
Circuit Description	<b>4-49</b>
UT400 Series 2 528 Frame TDM Crosspoint Carrier – 121323-1	<b>4-51</b>
General	<b>4-51</b>
Circuit Description	<b>4-51</b>
Controls And Indicators	<b>4-52</b>
UT4-528 Standard Digital Audio Input with TDM Board – 121288-1	<b>4-53</b>
General	<b>4-53</b>
Circuit Description	<b>4-53</b>
Controls and Indicators	<b>4-54</b>
Serial Diagnostic Port Commands	<b>4-55</b>
Rear Panel Connections	<b>4-56</b>

---

**Table of Contents**

---

121245-1 Rear Panel Layout (BNC)	<b>4-58</b>
Specifications	<b>4-58</b>
UT4-528 Standard Digital Audio Output with TDM Board – 121289-1	<b>4-59</b>
General	<b>4-59</b>
Circuit Description	<b>4-59</b>
Controls and Indicators	<b>4-60</b>
Specifications	<b>4-64</b>
Serial Diagnostic Port Commands	<b>4-65</b>
UT4-528 Digital Audio Digital to Analog (DAC) Output with TDM Board – 121326-1	<b>4-66</b>
General	<b>4-66</b>
Circuit Description	<b>4-66</b>
Controls and Indicators	<b>4-67</b>
Specifications	<b>4-69</b>
Rear Panel Connections	<b>4-70</b>
Serial Diagnostic Port Commands	<b>4-71</b>
UT4-528 Digital Audio Analog to Digital (ADC) Input with TDM Board – 121325-1	<b>4-72</b>
General	<b>4-72</b>
Circuit Description	<b>4-72</b>
Controls and Indicators	<b>4-73</b>
Specifications	<b>4-74</b>
Rear Panel Connections	<b>4-75</b>
Serial Diagnostic Port Commands	<b>4-75</b>
72x72 AV Router Components	<b>4-76</b>
Crosspoint Card - 121337-1	<b>4-76</b>
UT400 72x72 Audio Crosspoint Card – 121338-1	<b>4-78</b>
121332-1 SDI Module	<b>4-80</b>
UT400 Series 2 Advanced Input Card – 121395-1	<b>4-82</b>
Circuit Description	<b>4-83</b>
Controls And Indicators	<b>4-84</b>
Operational Modes	<b>4-86</b>
Serial Diagnostic Port Commands	<b>4-86</b>
Specifications	<b>4-87</b>
UT400 Series 2 Advanced Output Card – 121396-1	<b>4-88</b>
Power Supplies	<b>4-94</b>
UT400 Series 2 MOHO Video + MADI Output Card	<b>4-95</b>
General	<b>4-95</b>
Circuit Description	<b>4-96</b>

---

---

Controls And Indicators	<b>4-97</b>
Specifications	<b>4-98</b>
Rear Panel Connections	<b>4-99</b>
Serial Diagnostic Port Commands	<b>4-99</b>
UT400 Series 2 MIHI Video + MADI Input Card	<b>4-101</b>
General	<b>4-101</b>
Circuit Description	<b>4-101</b>
Controls And Indicators	<b>4-102</b>
Specifications	<b>4-103</b>
Rear Panel Connections	<b>4-103</b>
Serial Diagnostic Port Commands	<b>4-104</b>
UT400 Series 2 SMPTE 2022 Receiver (121400-1)	<b>4-106</b>
General	<b>4-106</b>
Circuit Description	<b>4-106</b>
Controls and Indicators	<b>4-108</b>
Rear Panel Connections	<b>4-109</b>
Terminal Interface	<b>4-110</b>
Local Monitoring Processor Menu	<b>4-111</b>
UT400 Series 2 SMPTE 2022 Transmitter (121401-1)	<b>4-116</b>
General	<b>4-116</b>
Circuit Description	<b>4-116</b>
Controls and Indicators	<b>4-117</b>
Rear Panel Connections	<b>4-118</b>
Terminal Interface	<b>4-119</b>
Local Monitoring Processor Menu –	<b>4-120</b>
K70 Network Processor Menu –	<b>4-120</b>
SMPTE 2022 Processor Menu –	<b>4-120</b>
Specifications	<b>4-124</b>
Rear Panel Considerations	<b>4-125</b>
MX Bus	<b>4-125</b>
Dip Switches	<b>4-125</b>
Video Ref A, Video Ref B	<b>4-125</b>
AES Ref	<b>4-125</b>
Power supplies	<b>4-126</b>
External Power Supply	<b>4-126</b>
Router Power supplies	<b>4-127</b>
LED Indications	<b>4-128</b>
	<b>4-129</b>

**CHAPTER 5**

*Troubleshooting*

In This Chapter **5-1**  
Subsystem Level Troubleshooting **5-2**  
Main Troubleshooting Chart **5-2**  
Video Subsystem Troubleshooting Table **5-4**  
Audio Subsystem Troubleshooting Table **5-5**  
Power Subsystem Troubleshooting Table **5-6**  
Power Supply Alarms **5-6**  
Control Subsystem Troubleshooting Table **5-7**  
System Controller Alarms **5-8**  
Control Panel Troubleshooting **5-9**  
    UNET Panels **5-9**  
    Ethernet Panels **5-9**

**APPENDIX A**

*Specifications*

In this Appendix **A-1**  
Power **A-2**  
Input Power and DC Power Specifications **A-2**  
Digital Video **A-3**  
    Digital Audio Specifications **A-4**  
Reference **A-5**  
    Reference Specifications **A-5**  
Control **A-6**  
    Control Specifications **A-6**  
Alarms **A-6**  
    Alarm Specifications **A-6**  
Physical **A-7**  
    Physical Specifications **A-7**  
Regulatory **A-8**  
    Regulatory Specifications **A-8**  
Connector Suppliers and USI Part Numbers **A-9**  
    Connector Suppliers **A-9**

---

---

## **APPENDIX B**

### *The Debug Port*

- Diagnostic Port Usage **B-1**
- Physical Connections **B-1**
- Baud Rate and terminal Settings **B-1**
- Terminal Settings **B-2**
- Recommended Terminal Emulation Program **B-2**
- System Diagnostics – Frame Controller Module **B-2**
  - 121222-1 Crosspoint card Diagnostic Interface **B-7**
  - 121323-1 TDM Audio Crosspoint Carrier for 528 Systems Diagnostic Interface **B-10**
  - 121248-1 Crosspoint card Diagnostic Interface **B-12**
  - 1242-1 Crosspoint Card Diagnostic Information **B-15**
  - SDI IO Card Diagnostic Information **B-16**
  - AES IO Card Diagnostic Information **B-18**
  - 121320-1/2 Triple MADI IO card Diagnostic Information **B-19**
  - Embedding SDI Output Card (121293-1/2) Diagnostic Information **B-20**
  - Dis Embedding SDI Input Card (121292-1) Diagnostic Information **B-21**
  - 121337-1 72x72 Crosspoint card Diagnostic Interface **B-22**
  - 121338-1 72x72 Audio Crosspoint card Diagnostic Interface **B-23**

## **APPENDIX C**

### *The UT4-528 Digital Audio Breakout Panel*

- Scope **C-2**
- The AES Breakout Panel Kit **C-2**
- Description of the AES Breakout Panel **C-3**
  - Analog Rear Panels Connected to Breakout Panel **C-4**
  - AES Balanced Rear Panels Connected to Breakout Panel **C-5**
    - Connection Examples 6
- Installation of the AES Breakout Panel **C-7**
- Label Instructions for the Utah-400 Breakout Panel **C-9**
  - Scope **C-9**
  - Application **C-9**



---

***In This Guide***

This guide provides instruction for the installation, configuration, and operation the Utah Scientific, Utah-400 528 and XL Router Systems. These routers contain redundant crosspoints with 44 to 88 slots for both the input and output and cards, and stand 20 and 40 rack units in height.

The following chapters and appendices are included:

- **Chapter 1**

"Introduction" summarizes the guide, describes basic router operation and describes the hardware and software components of the Utah-400 Digital Routing Switcher.

- **Chapter 2**

"Hardware Installation" provides instructions for installing the Utah-400 Digital Routing Switcher in your facility.

- **Chapter 3**

"Configuration and Operation" provides specific information regarding the configurations of this unit, and necessary equipment handling (operation).

- **Chapter 4**

"Utah-400 Router Components" provides basic information about the Input, Output, Crosspoint, Interface board and Power Supplies. Included is general information about LED indicators and alarms present on each board type.

- **Chapter 5**

"Troubleshooting" looks at some of the common hardware and software problems, diagnostics and solutions available to the user on site. Included in this section is information on the various avenues to contact Utah Scientific Technical Services and tips on discussing equipment problems.

- **Appendix A**

"Specifications" lists all system specifications, including Audio, Video, physical, power, and regulatory.

- **Appendix B**

"The Debug Port" contains information regarding the current Utah 400 firmware, along with setup and use of the system Debug Cable.

- **Appendix C**

"The Utah 400 Digital Audio Breakout Panel" applies to the installation and operation of the AES Digital Audio Break Out Panel, a component designed to simplify the installation of the Utah-400 Balanced Digital Audio Routing System.

---

## *Conventions*

The following conventions are used throughout this guide:

- Connectors and terminators will be indicated by bold, upper case text in Arial Black font.  
For example:
  - Connect the **MX-Bus** to **J-1**
- **Operator Actions** will be indicated in Helvetica Bold where a board is inserted, removed and/or an action is required in the Troubleshooting or configuration sections of this manual. There will usually be a graphic to accompany the instruction(s). For example:
  - **Insert** the expansion Input board in slot 6.
  - **Switch** the suspected bad input **to a known good input** to verify output "X".
- The use of bullets indicates a random order of operation or to draw the readers attention to specific items.
  1. The use of numbers in specific operations or lists indicates a "**recommended order of operation**" to perform specific tasks. Bulleted items may be below numbered items to highlight tasks or indicate the operation(s) may be performed at random.

---

## *Abbreviations*

The following abbreviations may be used in this guide: See Appendix A for an additional Glossary of Terms and further definitions.

**TABLE 1. Common Abbreviations and Mnemonics**

<b>Abbreviation</b>	<b>Description</b>
ATR	Audio Tape Recorder
AES	Audio Engineering Society
CPU	Central Processing Unit
DTR	Digital Tape Recorder
EBU	European Broadcast Union
ENET	Ethernet
HDTV	High Definition Television
I/O	Input / Output
IP	Internet Protocol
JPEG	Joint Photographic Experts Group
M-JPEG	Motion – JPEG
MPEG	Motion Picture Experts Group
MX-Bus	Utah Router Control Comm. Bus
RMS	Router Management System
RU	Rack Unit
SDI	Serial Digital Interface
U-Net	Utah Control Panel Comm. Network
UTP	Unshielded Twisted Pair
VTR	Video Tape Recorder

---

## *Terms*

The following terms are used throughout the documentation in this guide:

- **"Operator"** and **"User"** refer to the person using or operating the Utah-400 Digital Router System.
- **"System"** refers to the entire interconnected Utah-400 System including control panels, routers, software, and chassis.
- **"Mainframe"** refers to the Utah-400 chassis plus redundancy.
- **"Input"** refers to an audio or video signal source that is connected to the Utah-400 main frame.
  - One video input represents one High Definition or Serial Digital Interface video output signal.
  - One audio input represents a single monophonic track from an analog audio source.
  - One digital audio input represents two tracks (left and right channel) from a digital audio source.
- **"Source"** refers to an audio or video device whose output signals are connected to the Utah-400 mainframe inputs. Examples of audio / video sources are ATR's, VTR's, DTR's, cameras, video / audio routers, audio mixers, graphics systems, and satellite feeds.
- **"Output"** refers to the Utah-400 audio or video signals from the Utah-400 "Outputs", which are connected to the 'destination device'. This term also includes the physical output connectors on the frame.
- **"Destination"** refers to the device, which is receiving the Utah-400 output signal. This could include VTRs, monitors, satellite feeds, or video / audio routers.
- **"Signal Level"** refers to the logical level of the audio / video routers in relation to the entire connected system(s). Typically, the Utah-400 occupies levels above 1, with master control occupying the lowest logical level.
- **"Hot Swappable"** refers to a printed circuit board, which can be removed or replaced with system power "on".
- **"Control Panel"** refers to the physical human interface used to control the various systems in use.
- **"Display"** is the 'LCD Display' on the panels in use.

- **"Monitor"** refers to the monitor attached to the monitor matrix port of a video or audio router system.
- **"High Definition"** " refers to signals conforming to the SMPTE -292 specification. The typical high definition data rate is 1.485 Gb/sec or 1.483 Gb/sec and a 16:9 Aspect Ratio Picture characterizes this technology.
- **"Serial Digital" Interface (SDI)"** refers to the serial digital video signal operating at either SMPTE -259 in ABCD or SMPTE -344.

---

### *Routing Switcher Basics*

A routing switcher is a specialized form of broadcast equipment that allows the user to connect large numbers of source and destination devices together electronically – without patching or running cables across floors and without significant signal loss.

The routing switcher solves connectivity problems and increases signal qualities in a wide variety of applications. The technologies of routing switchers now include the standard analogue, digital video, digital audio, and increasingly the high definition formats.

The routing switcher provides the user with the following advantages:

- Many signal levels (determined by the system size) may be switched simultaneously.
  - A simple route connects (switches) one signal level from one source (for example a VTR) to one destination (a monitor).
  - A complex route would connect multiple signal levels from one source to multiple destinations, including tie lines. For example, a satellite feed to a group of VTRs and monitors.
- Audio and video signal levels can be switched in groups (all follow takes) or individually (breakaway takes). Any input can be switched to any output, limited only by the matrix size.
- The Routing Switcher may be controlled manually via control panels, or with computer controlled automation.

## Switching Matrix

A switching matrix is the internal array of inputs, crosspoints and outputs that allow a routing switcher to perform the task of routing signals from sources to destinations. The figure below illustrates a simple 10 X 10 switching matrix – with 10 Inputs and 10 Outputs.

Note the following points regarding the illustration:

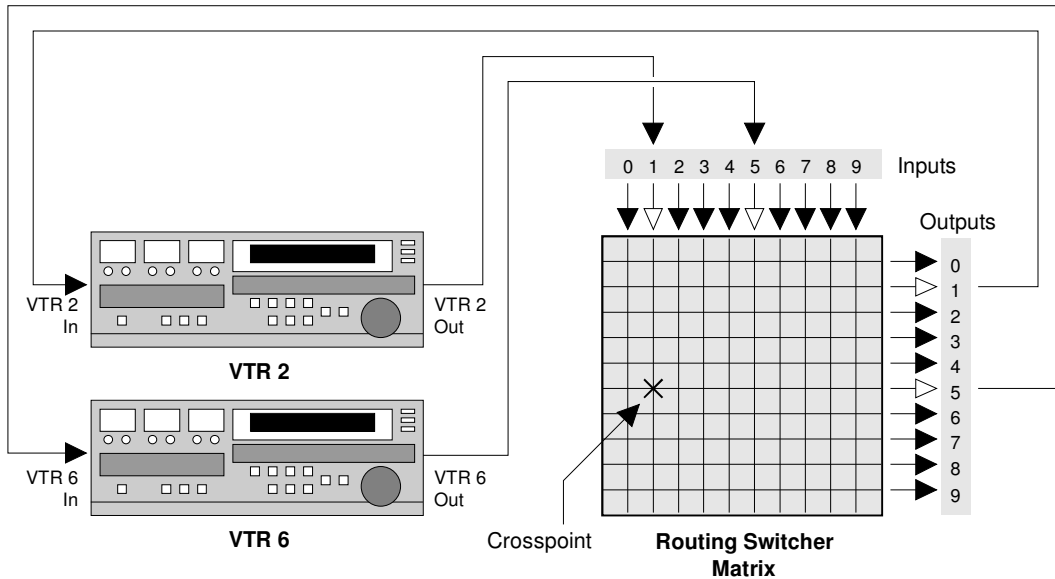

- Each VTR is fully connected to the matrix – all audio/video inputs and outputs.
- A cross-point (represented by an **X**) is the internal electronic connection of the input to the output – either audio or video.
- When the cross-point is turned "**ON**" the connection is made between the source and destination. The action of turning the cross-point on is known as making a "**Take**".
- When an entire audio/video array is connected in this manner, from all of the devices in your facility, you have full routing flexibility.
- Without re-cabling or re-patching, a device can play back one moment (as a source) and record the next moment (as a destination).

## Signal Levels

A "signal level" represents one of many specific types of audio or video elements that a routing switcher is capable of handling. The typical signals capable of being switched are:

- Analog Video
- Analog Audio (stereo with left and right channels).
- Digital Video
- Digital Audio (dual channel – stereo pair)
- High Definition Video.

Some systems may be configured with one signal level, while others may be configured with multiple signal levels.

While the diagram in the previous section shows only one signal level, a multi-signal level system is capable of routing any combination up to 32 levels – each with its own matrix and cross-points.

The figure below illustrates **eight signal levels** in a 10 X 10 matrix system.

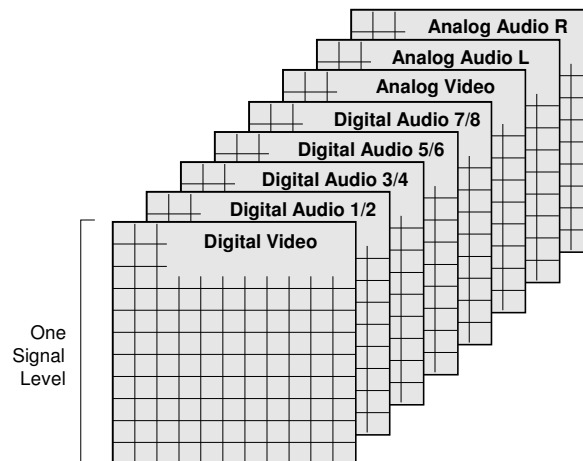

Signal routers are typically much larger than a 10 X 10 matrix, depending on user needs. Each signal level may also have different sizes of matrices and do not all need to be the same size.



### The Utah-400 Routing Matrix

The Utah-400 router utilizes a '3 board' architecture that consists of an input-crosspoint-output card combination. This unique 3-board technology allows for a greater flexibility of input and output combinations available to the user. Each input or output board contains twelve signal paths so the user can expand in groups of twelve up to the maximum capacity of the router. These I/O cards can be HD, SD, Analog, Optical, or AES.

Features of this technology include signal presence indicators on both the input and output boards. The status of the router input and output states can be continuously monitored via the debug port (see Appendix B).

The input signal is received and equalized on the input board. A valid input will illuminate the Signal Presence Detector LED and also status at the debug port.

From this point the signal is routed to the crosspoint, where the operator has made a "Take", selecting the routing path of this input to its output.

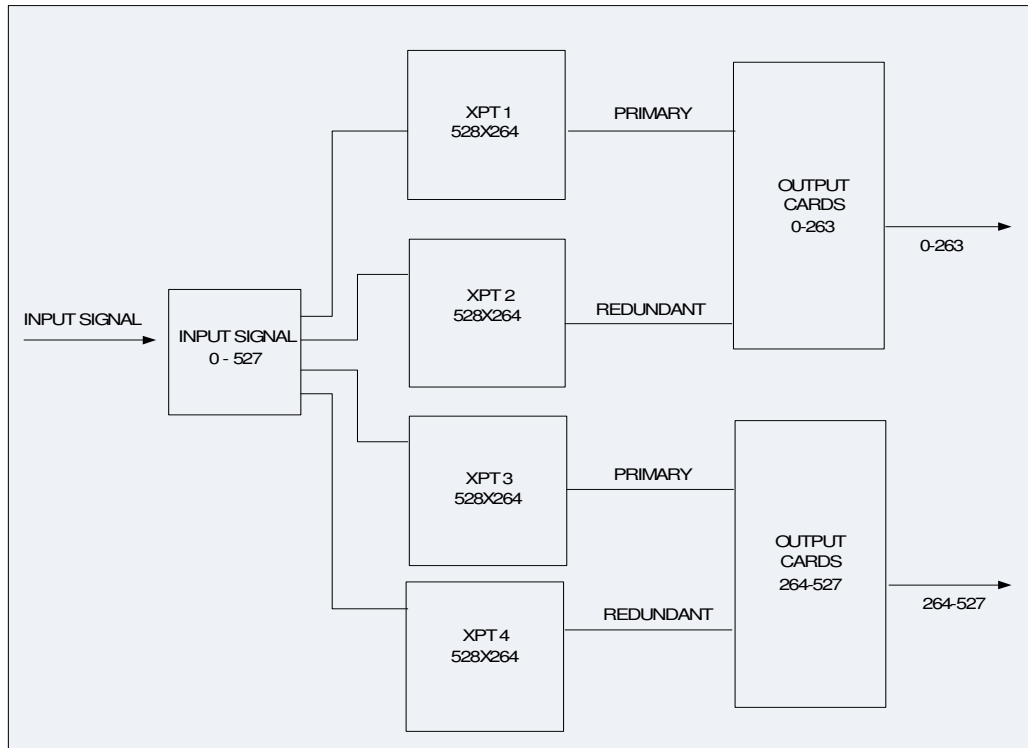
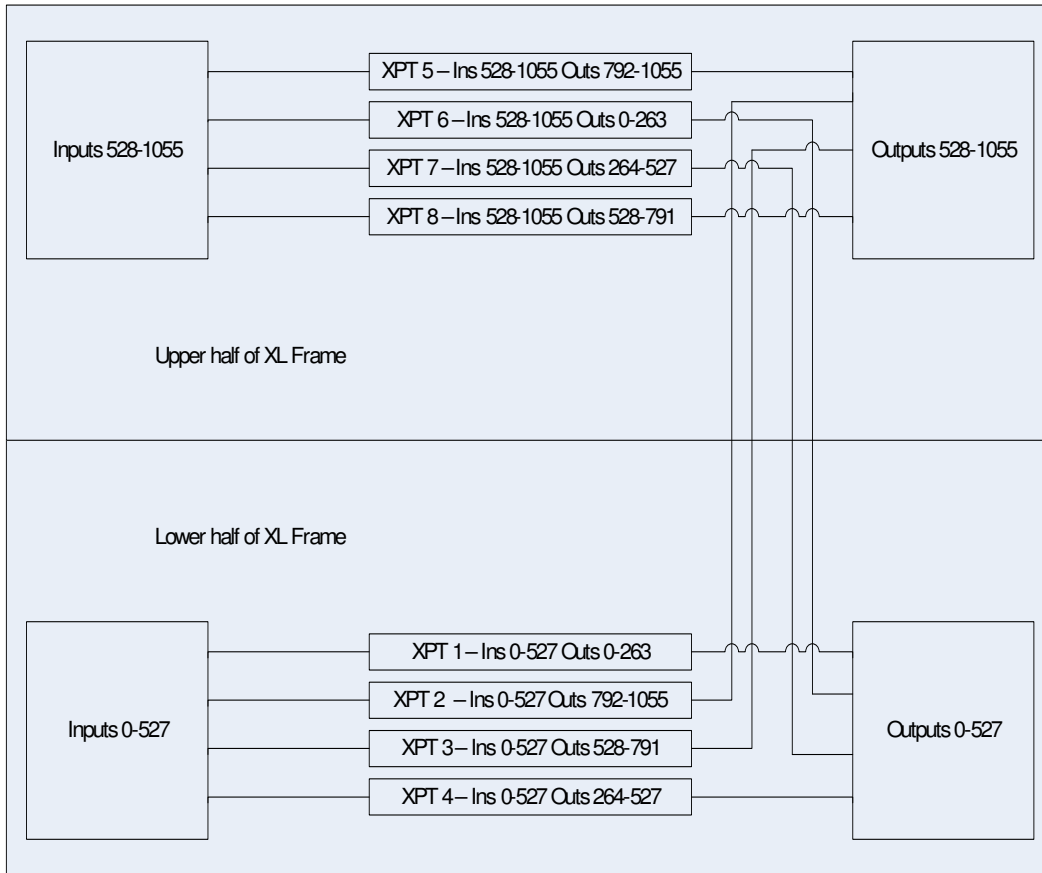

FIGURE 1-1. 528x528 Matrix Block Diagram

The output from the crosspoint is directed to its proper path on the output bus and the appropriate output board slot. When the output board detects a valid output signal, it will illuminate the appropriate Signal Presence LED. From this point the output signal is sent to its output driver and its BNC.



**FIGURE 1-2. XL System block diagram**

---

The 528 and XL systems utilize all the same plug-in cards to create their configurations. The 528 frame offers redundant crosspoints and a 528 port input by 528 port output system in 20 RU, while the XL system provides no dedicated cross point redundancy, but a 1056 port router in 40 RU.

The XL system is a combination of two 528 frames, so the power and cooling infrastructure of each frame is preserved.

The two chassis share a motherboard that allows for the sharing of pre-routed output busses from crosspoints in the lower half that drive to the upper half, and from the upper half to the lower half. Please see the IO ranges in the block diagram and the corresponding crosspoint numbers in the component location diagram to determine the IO range of each IO and crosspoint card in the system.

The 288 and 144 routers use many of the same components as the 528 and XL routers, but contain crosspoint cards that are unique to each frame size. The control I/O connections, configuration dipswitches, input and output cards, and frame control modules are the same for all four system types.

## Component Locations

### XL Configuration

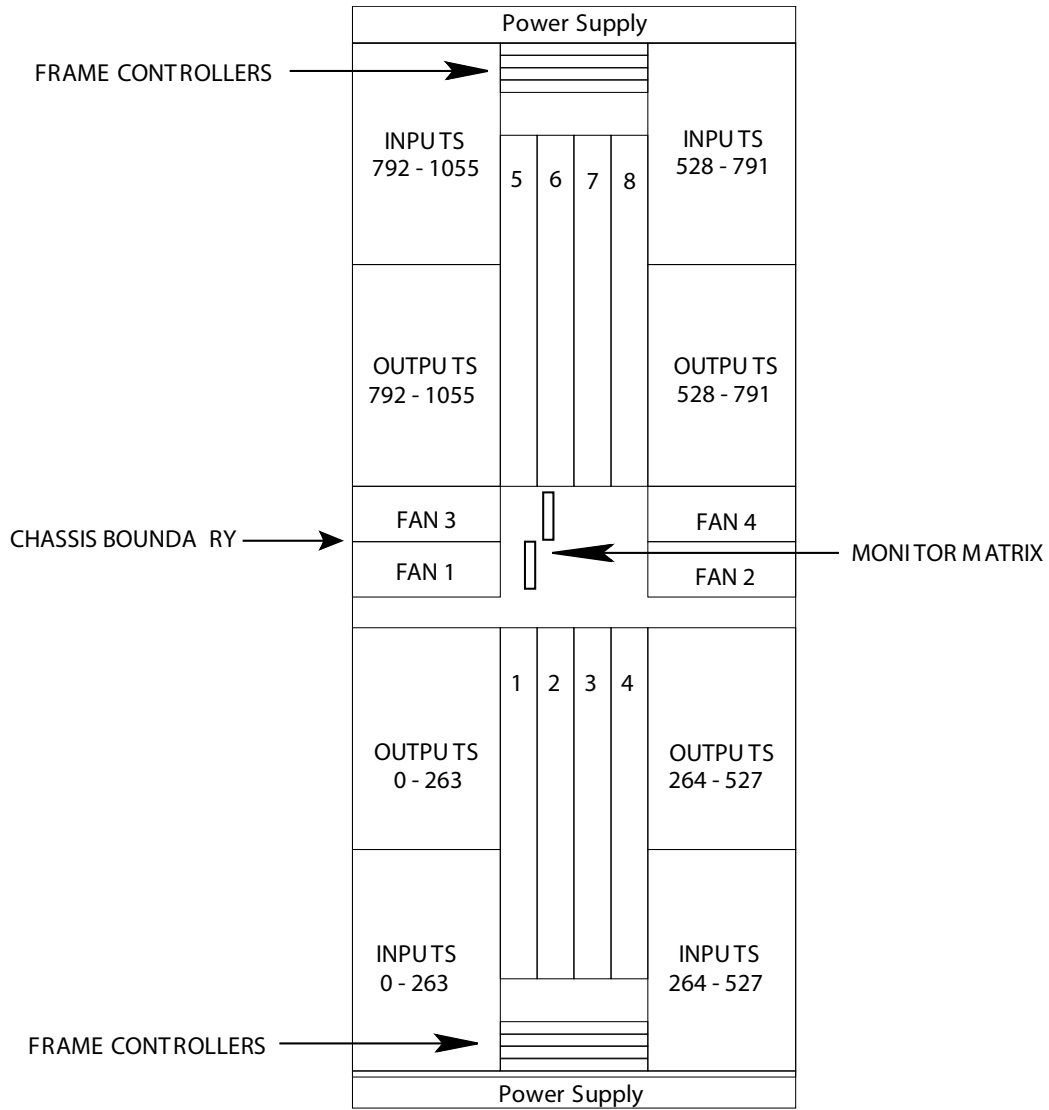

FIGURE 1-3. The Utah-400 XL Configuration

---

**Component Locations**

---

- The XL Router Includes: - *redundant cards optional*
  - (8) Crosspoint Boards
  - (0) Redundant Crosspoint Boards
  - (88) Input Boards
  - (88) Output Boards
  - (2) External Power Supply Frames
  - (4) Frame Controller Modules
  - (4) Fan Modules
  - (2) Monitor Matrix boards

### 528 Configuration

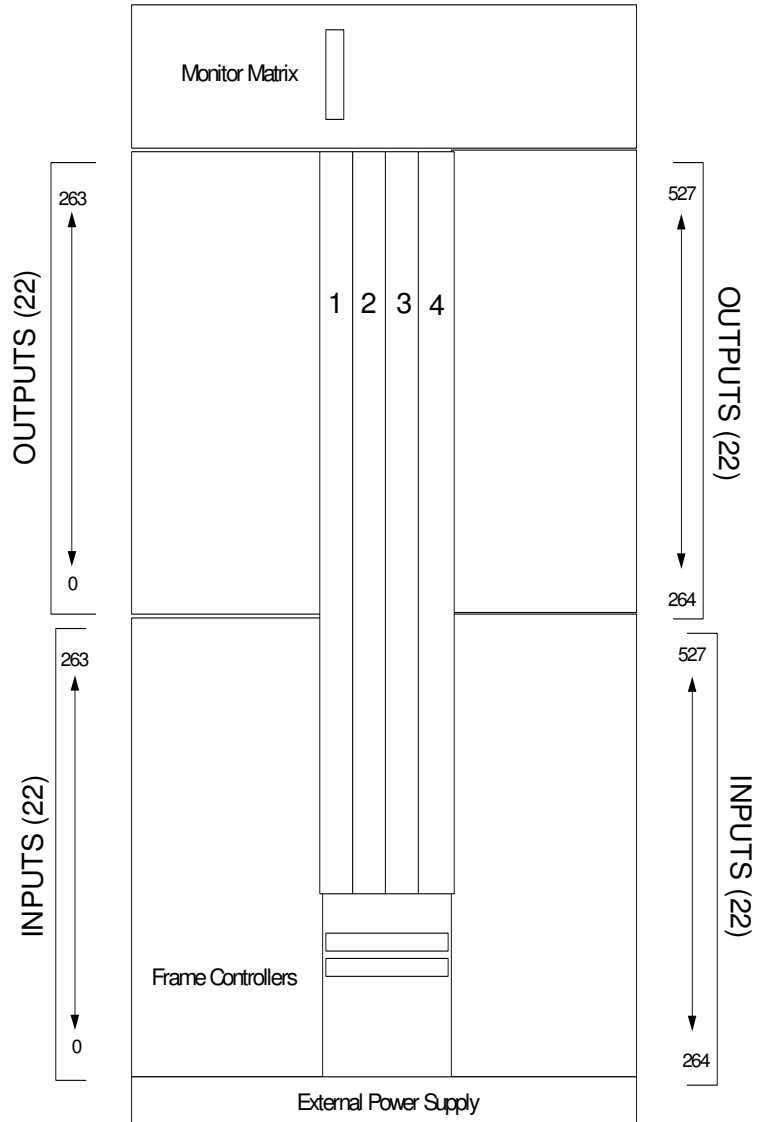

FIGURE 1-4. The Utah-400 528 x 528 Configuration

---

## Component Locations

---

- The 528 x 528 Router Includes: - *redundant cards optional*
  - (2) Crosspoint Boards (528 x 264)
  - (2) Redundant Crosspoint Boards
  - (44) Input Boards (000 – 527)
  - (44) Output Boards (000 – 527)
  - (1) External Power Supply Frame
  - (2) Frame Controller Modules
  - Fan Modules
  - Monitor Matrix

### 288 Configuration

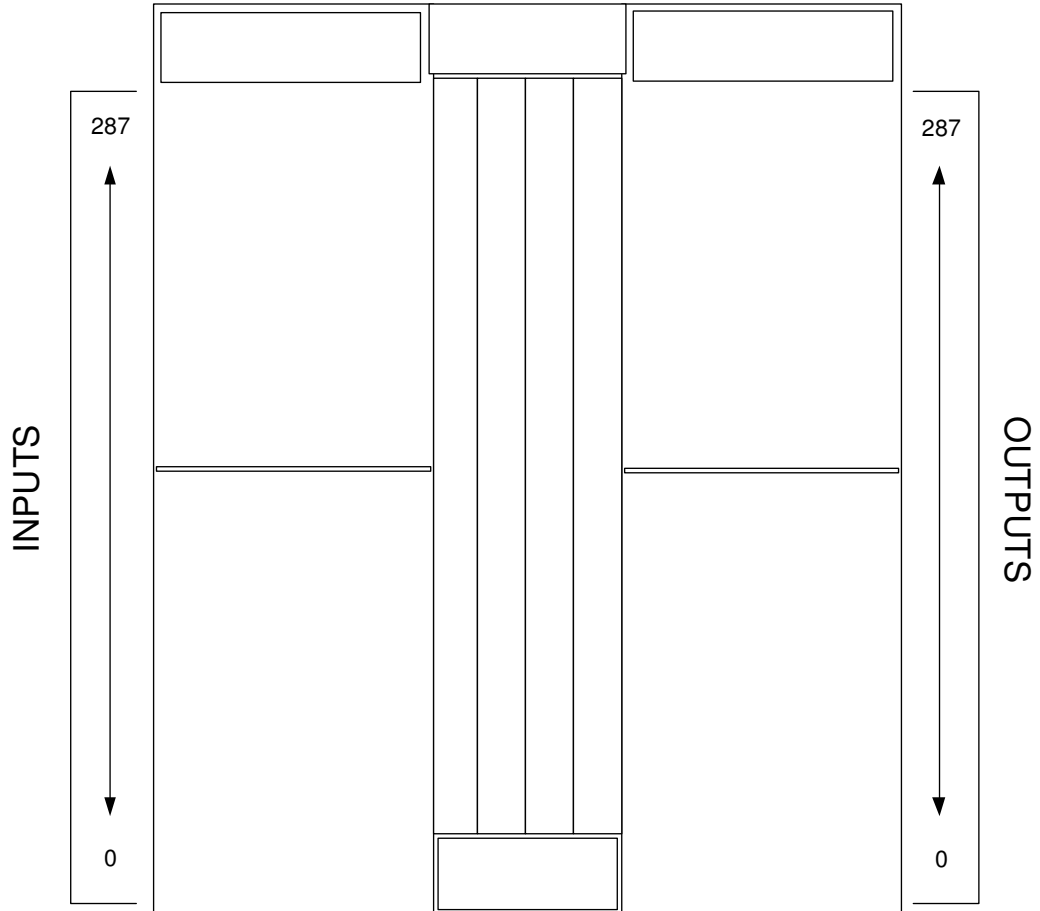

FIGURE 1-5. The Utah-400 288x288 Configuration

---



---

## Component Locations

---

- The 288 x 288 Router Includes: - *redundant cards optional*
  - Crosspoint Board (288 x 288)
  - Redundant Crosspoint Board
  - (24) Input Boards (000 – 287)
  - (24) Output Boards (000 – 287)
  - (1) External Power Supply Frame
  - (2) Frame Controller Modules
  - Fan Modules
  - Monitor Matrix integral to the crosspoint card

***Note that the monitor matrix in 288 frames is driven by the Primary crosspoint card. If it is removed from the system for some reason, the monitor matrix will not function.***

## 144 Configuration

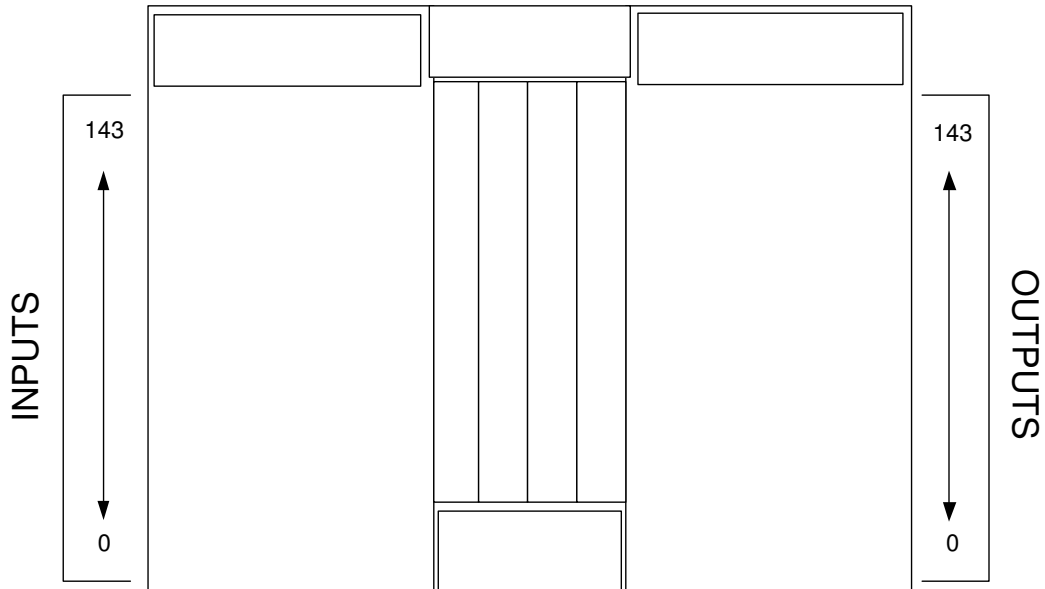

**FIGURE 1-6. The Utah-400 144 x 144 Configuration**

- The 144 x 144 Router Includes: - *redundant cards optional*
  - (1) Crosspoint Boards (144 x 144)
  - (1) Redundant Crosspoint Boards
  - (12) Input Boards (000 – 143)
  - (12) Output Boards (000 – 143)
  - (1) External Power Supply Frame
  - (2) Frame Controller Modules
  - Fan Modules
  - Monitor Matrix - integral to the Primary Crosspoint

**Note that the monitor matrix in 144 frames is driven by the Primary crosspoint card. If it is removed from the system for some reason, the monitor matrix will not function.**

### 72x72 Configuration

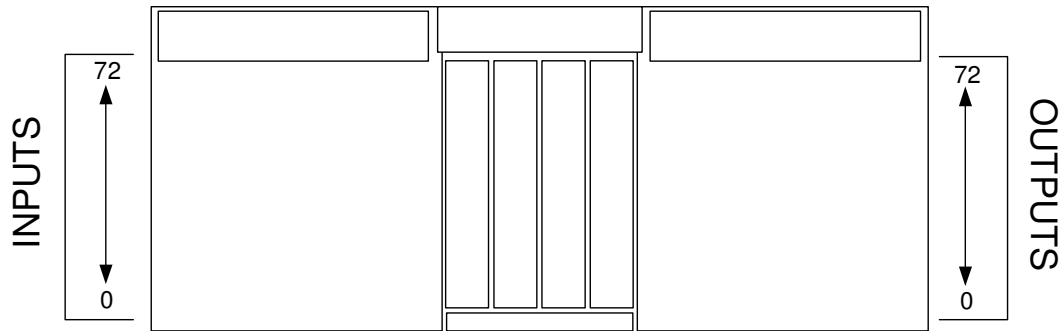

FIGURE 1-7. The Utah-400 72 x 72 Configuration

---

- The 72 x 72 Router Includes: - *redundant cards optional*
  - (1) Crosspoint Boards (72 x 72)
  - (1) Redundant Crosspoint Boards
  - (6) Input Boards (000 – 72)
  - (6) Output Boards (000 – 72)
  - (2) External Power Supplys Frame
  - (2) Frame Controller Modules
  - Monitor Matrix - integral to the Primary Crosspoint

**Note that the monitor matrix in 72 frames is driven by the Primary crosspoint card. If it is removed from the system for some reason, the monitor matrix will not function.**

## *UT-400 Embedded Signal Processing Functionality*

The Series 2 routers were designed with one more redundant, high speed data path from the IO cards to the crosspoint array than is necessary for their base operation as crosspoint based audio or video routers. This path is used, among other things, to carry a TDM based communications signal from input cards where it is generated, to a central crosspoint array where it is switched, and finally to an output card slot where the signal can exit the router as AES, part of a MADI signal, or as an embedded audio channel on a video output.

This high speed TDM bus has a maximum capacity of 256 audio channels. In the current system, the max usage is 192 (12 video sources or destinations x 16 channels of audio each, per card slot).

The central element to the TDM matrix is the crosspoint. This assembly is required to disassemble the incoming TDM streams and re-assemble them based on the switching commands from the SC4 into the correct stream to go to a particular output slot.

There are two versions of the crosspoint module –

- A 12 port x 12 port assembly, which results in a 2304x2304 effective switching matrix size. This is USI Part Number 121295-1.
- A 16 port x 16 port assembly, which results in a 3072x3072 effective switching matrix size. This is USI Part Number 121296-1.
- The number of ports directly relate to the number of slots that each card can support when installed in a frame. The 12 port card is used in UT400/72 and UT400/144 chassis, while the 16 port version is used in larger frames.
- 72 router – All inputs and outputs.
- 144 router – All inputs and outputs.
- 288 router – Input slots 0-191 and output slots 0-191.
- 528 router – Input slots 0-191 and output slots 0-191.
- XL router – Input slots 0-191 and output slots 0-191.

To enable a standard Series 2 video router with the TDM functionality, two items are required.

- A timebase submodule must be placed on both of the Frame Controller Modules within a frame.

- A TDM audio crosspoint must be placed on the crosspoint cards within the system. Note that in 528 systems, the TDM submodules install on Video Crosspoint numbers 0 and 2, and in the XL router the TDM submodules install on Video Crosspoint numbers 0 and 3.

Once the FCM in the system recognizes this configuration, it will report to the SC4 that the TDM sub router is present, which will allow it to be switched as any other router type is. This TDM Audio subrouter is ALWAYS defined as being at the video router level + 1. (IE, if the video router is on MX Bus level 2, the audio subrouter will respond to commands on router level 3.)

The numbering scheme that controls this crosspoint array is slot based and accommodates the maximum expansion size of the TDM bus. This means that the signals that enter the TDM crosspoint from input card slot 1 are 0-191 on the MX Bus. The signals that enter from input card slot 2 are 256 – 447, etc. The outputs conform to this standard as well. The table below details all of the control information.

TDM Crosspoint Port to MX-Bus IO number lookup

TDM Input Port	First Input	Last Input	TDM Output Port	First Output	Last Output
1	0	191	1	0	191
2	256	447	2	256	447
3	512	703	3	512	703
4	768	959	4	768	959
5	1024	1215	5	1024	1215
6	1280	1471	6	1280	1471
7	1536	1727	7	1536	1727
8	1792	1983	8	1792	1983
9	2048	2239	9	2048	2239
10	2304	2495	10	2304	2495
11	2560	2751	11	2560	2751
12	2816	3007	12	2816	3007
13	3072	3263	13	3072	3263
14	3328	3519	14	3328	3519
15	3584	3775	15	3584	3775
16	3840	4031	16	3840	4031

Each TDM enabled IO card fills or draws from this TDM Bus in a different manner, but the consistent operation is that they fill or remove audio from the lowest order slots up to their capacity.

## TDM Enabled IO Cards

Following is a list of USI line cards that can generate or receive TDM streams.

TDM Enabled IO Cards for S2 Routers

USI PN	Description	Capacity	Other Signal Support	Rear Panel
121292-1	12 Port De-Embedder card	192	12 3G Inputs, 1:4 Fanout	121226-1
121293-1	12 Port Embedder card	192	12 HD Outputs, 2:1 Mux	121226-1
121320-1	Triple Port MADI Input Card	192	None	121324-1
121320-2	Triple Port MADI Output Card	192	None	121324-1
121288-1	TDM Enabled AES Input Card	24	12 AES Ins, 1:4 fanout	121245-1
121289-1	TDM Enabled AES Output Card	24	12 AES Outputs, 2:1 Mux	121245-1
121286-1	TDM Enabled MADI In Card	64	12 AES Inputs, 1:4 Fanout	121299-1
121287-1	TDM Enabled MADI Out Card	64	12 AES Outputs, 2:1 Mux	121299-1
121325-1	TDM Enabled ADC In Card	24	12 AES Inputs, 1:4 Fanout	121327-1
121326-1	TDM Enabled DAC Out Card	24	12 AES Outputs, 2:1 Mux	121327-1
121395-1	Advanced Input Card	192	12 3G Inputs, 1:4 Fanout	121397/98-1
121396-1	Advanced Output Card	192	12 3G Outputs, 2:1 Mux	121397/98-1
121450-1	MIHI MADI/Video Input Card	192	12 3G Inputs, 1:4 Fanout	121452-1
121451-1	MOHO MADI/Video Output Card	192	12 3G Outputs, 2:1 Mux	121452-1

## Supported Signal Types

All AES signals contributed the TDM matrix either from a video stream, an AES input card or a MADI input card, must be at 48KHz sample rate and synchronous to the AES DARS reference presented to the rear of the router.

No sample rate converters are present in the system, so if an asynchronous signal or one with a different sample rate is desired to be part of the system, it must be externally sample rate converted to match the applied DARS reference prior to being presented to the router.

## Delay Considerations

There are slight processing delays at various places in the Series 2 routers due to the requirement to align the incoming signals to the reference prior to adding them to the TDM stream.

Depending on the routing of the signal, (IE, AES in to embedded video out vs. AES in to AES out) these delays can vary.

Audio Delays – At each input, whether MADI, AES or Video, the incoming AES audio is aligned to the DARS reference presented to the router. Depending on the timing of that signal, this alignment will result in slightly more than one to slightly less than two AES samples. This equates to between 20.83 and 41.66 micro seconds.

At the TDM crosspoint, a delay to equalize all of the incoming TDM streams results in another delay of 1.2 micro seconds.

At the input of the output card, one AES sample is gathered before audio output begins, so this results in another delay of 20.83 micro seconds.

Total Audio delay is then between 42.86 and 63.69 micro seconds.

Video Delays – At the input card, because the SDI signal is duplicated prior to processing and an unprocessed copy sent to the video crosspoint core, there is no delay.

At the output card, the video signal is always deserialized and re-serialized even if no active audio insertion is happening. The delay of this process is less than 5 micro seconds for HD-SDI, and less than 10 micro seconds for SD-SDI.

### **Shuffling versus Routing**

Another feature closely related to but mutually exclusive to TDM Routing is ‘Shuffling’, that is performed by a derivative of the 121293-1, the 121293-2. This board has a separate firmware load that allows it to rearrange the 16 audio channels in each individual video stream to whatever is desired by the customer. This functionality is completely standalone on that particular output card versus the routing capability of the other TDM designs.





*In This Chapter*

This chapter provides instructions for installing your Utah-400 router in your facility. The following topics are covered:

***Caution:*** *To avoid damage to the system, do not connect AC power until the hardware is fully installed.*

Unpacking and Inspection .....	2-2
Installing Physical Equipment - 528 and XL Systems .....	2-16
Mounting Equipment in Rack Frames - 528 Systems .....	2-17
Installing the MX-Bus Cables .....	2-21
Installing the Analog Audio Input and Output Cables .....	2-33
Connecting and Disconnecting Power .....	2-34
DC Connectivity.....	2-36
Pre Power-Up Checks .....	2-37
UTAH-400 Series 2 - 72x72 AV Router .....	2-40
Hardware Checkout .....	2-42

---

## *Unpacking and Inspection*

### **528 Systems**

When you receive your Utah-400 system, inspect each shipping carton for signs of damage. Contact your dealer and shipper immediately if you suspect any damage has occurred during shipping. Check the contents of each carton against your Utah Scientific order and verify them against the shipping manifest. If any items are missing, contact your dealer or Utah Scientific immediately.

Save the shipping box and material for future use, in case the unit may have to be shipped back to Utah Scientific.

***Caution: A fully loaded Utah-400 528 router system weighs approximately 230 pounds***

Each router is wrapped in anti-static plastic prior to boxing up. The following illustration shows the typical packaging of a single Utah-400 router.

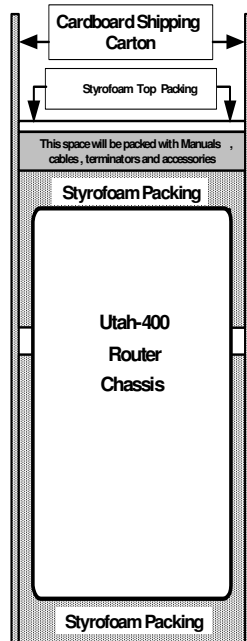
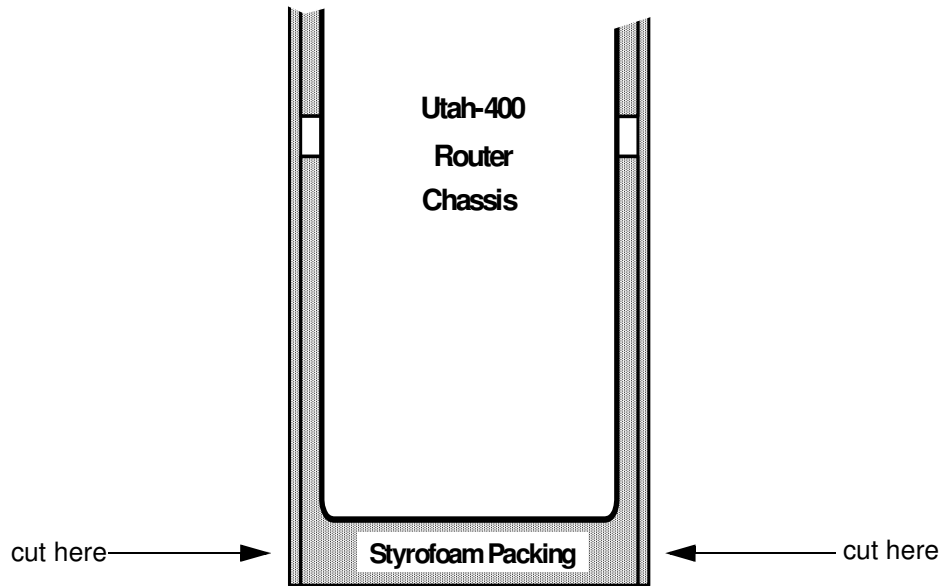

**FIGURE 2-1. Utah-400 528 Packaging**

---

**Recommended unpacking method:**

1. With carton setting upright, open the top.
2. Remove the Styrofoam packing material in the top of the box.
3. Remove the accessories.
4. Remove the Styrofoam packing from the top of the Utah-400.
5. Carefully cut the packaging around the base of the unit (see illustration below), then pull the shipping container away from the chassis.
6. When the Utah-400 is exposed, lift it to a stable bench or cart.
7. With the Utah-400 sitting on a bench or cart, remove the anti-static wrap covering the router and save for future use.
8. Move the router to the installation site.



**FIGURE 2-2. Chassis removal from carton**

## XL Systems Carton Handling and Chassis Management

When you receive your Utah-400 system, inspect each shipping carton for signs of damage. Contact your dealer and shipper immediately if you suspect any damage has occurred during shipping. Check the contents of each carton against your Utah Scientific order and verify them against the shipping manifest. If any items are missing, contact your dealer or Utah Scientific immediately.

Save the shipping box and material for future use, in case the unit may have to be shipped back to Utah Scientific.

***Caution: The Utah-400 XL router system weighs over 600 pounds***

Each router is wrapped in anti-static plastic prior to boxing up. The following image series shows the typical case removal of the Utah-400 XL system.

Please have the necessary tools ready (hammer and crowbar) for the wooden carton disassembly that follows. It is also recommended that six people assist in the rack/chassis removal and placement.



**FIGURE 2-3. Carton truck removal - 1**

---



FIGURE 2-4. Carton truck removal - 2

---



FIGURE 2-5. Carton top removed - 1

---



FIGURE 2-6. Carton top removed - 2



FIGURE 2-7. Carton housing lifted from base - 1

---

**Unpacking and Inspection**

---



**FIGURE 2-8. Carton housing lifted from base - 2**

---



**FIGURE 2-9. Carton housing separated from base**

---



**FIGURE 2-10. Rack lifted off carton base**

---



**FIGURE 2-11. Rack lifted away from carton base**

---





**FIGURE 2-12. Rack carried to staging area**

---



**FIGURE 2-13. Rack brought upright**

---



**FIGURE 2-14. Rack upright, ready for final location move**

---

## Transferring an XL system between Equipment Racks

In certain instances, a different equipment rack is required other than the one shipped by the Utah Scientific factory. The following description and illustration set will assist you in completing a chassis-to-rack swap when necessary.



***IMPORTANT: PLEASE OBSERVE THE FOLLOWING BEFORE LIFTING THE XL CHASSIS***

- ***YOU MUST INCLUDE 8 INDIVIDUALS, EACH CAPABLE OF LIFTING 100 LBS.***
- ***EACH PERSON SHOULD WEAR A BACK BRACE AND GLOVES.***
- ***UTAH SCIENTIFIC INC. ASSUMES NO LIABILITY FOR PERSONAL INJURY OR DAMAGE TO EQUIPMENT.***

With the XL chassis completely removed from the container, lift off the panel doors, then carefully lower the chassis to the floor so that it is resting face up, and remove all the front mounting screws (as shown).

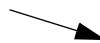

**FIGURE 2-15. XL in shipped rack**

With all screws removed, begin lifting the chassis from the bottom of the unit.

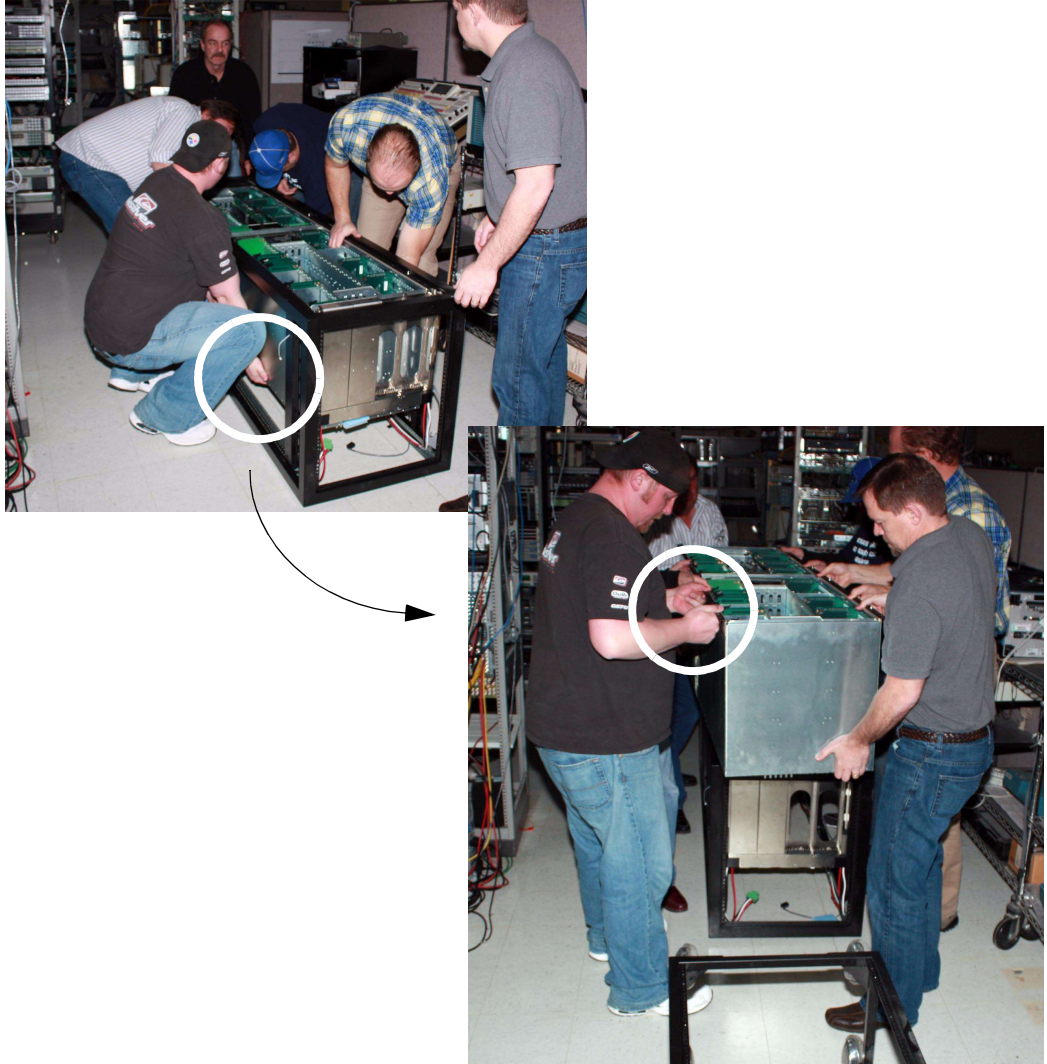

Once the front of the chassis has cleared the top of the frame (by several centimeters), allow each person to **one-by-one** reposition their hands to the lip on the front of the chassis (as shown).

**FIGURE 2-16. Initial chassis lift out procedure**

---

---

**Unpacking and Inspection**

---

Lifting from the chassis lip, all attendants will carefully walk the router to the replacement rack, which should be positioned lengthwise next to the original rack.



**FIGURE 2-17. XL chassis lift and carry**

Reverse the lift-out process by lowering the chassis into the new rack, and like before, each individual should shift their hold (**one-by-one**) from the chassis lip to the rack bottom.



**FIGURE 2-18. XL placement into the new rack**

---

---

**Unpacking and Inspection**

---

Once the chassis has been seated in the new rack, replace all front mounting screws and lift the assembly into its original upright position.

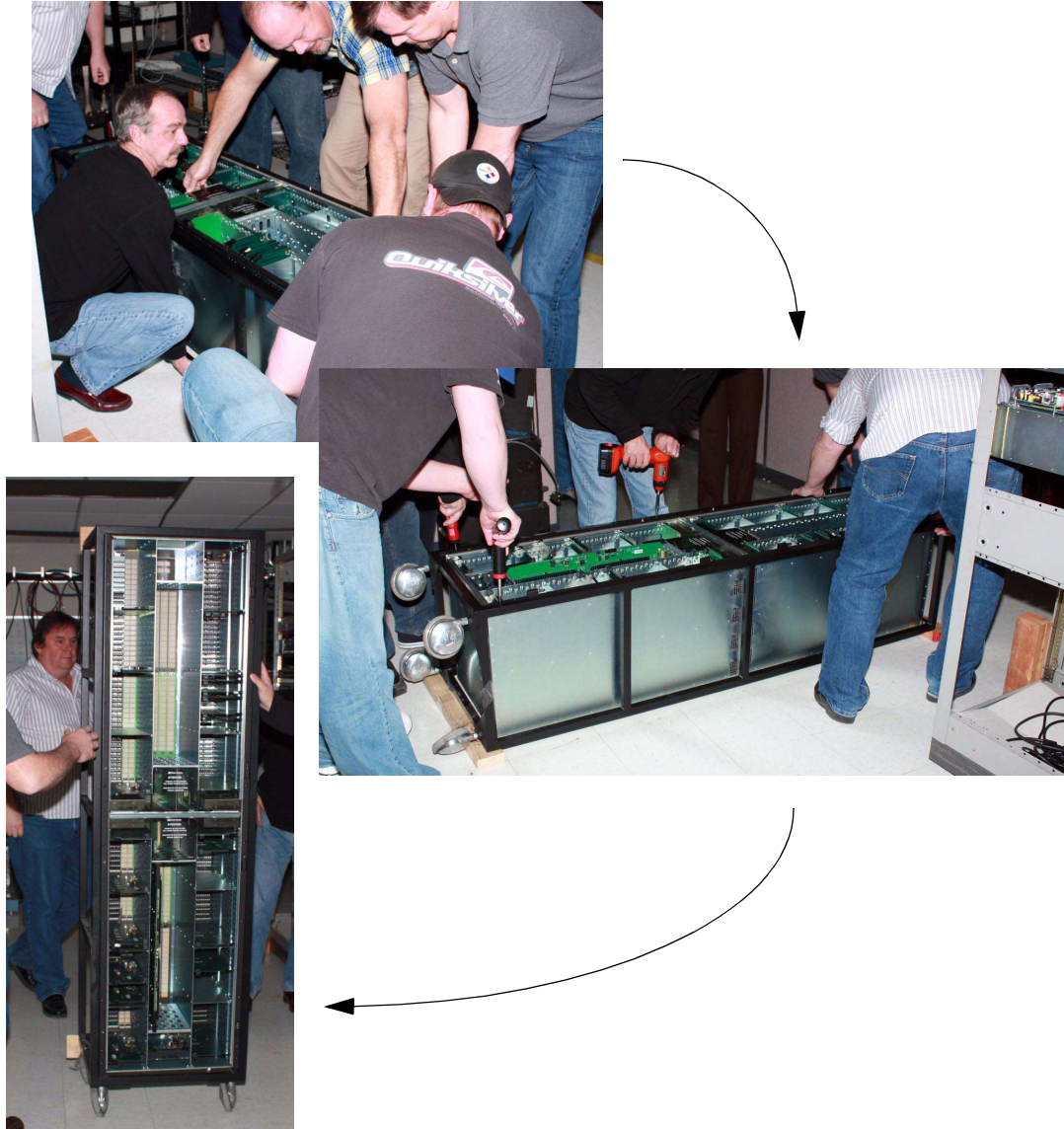

**FIGURE 2-19. XL chassis - new rack positioning and upright placement**

---

### *Installing Physical Equipment - 528 and XL Systems*

Installation of your Utah-400 Video and/or Audio router may require some or all of the following steps:

1. Mounting equipment in rack frames.<sup>1</sup>
2. Installing MX-Bus cables.
3. Connecting the AES Reference Signal.
4. Determining and Setting the Router Signal Level(s).
5. Installing Audio/Video signal cables.
6. Connecting power.
7. Connecting the SMPTE alarm port.
8. Hardware checkout.

---

1. The Utah-400 XL System ships in its own equipment rack



---

## *Mounting Equipment in Rack Frames - 528 Systems*

### **Installing the Utah-400 Digital Routing Switcher**

Use the following steps to install the Utah-400 Systems into the rack frames:

1. Determine the vertical layout of your frames before you begin the installation. Please note:
  - You may wish to place blank panels between the systems to increase ventilation and make cabling easier.
  - You may wish to install the systems in a way to reflect the priority of audio and video signal levels.
  - *The 1 rack unit power supply frame must be installed directly below the audio or video frame.*
    - **For example:** If digital video is signal level 1 and digital audio is signal level 2, the digital video may occupy a lower position in the rack frame.

**Note:** *The illustration below is an example of a simple rack frame layout.*

2. Once your layout is determined, remove the front cover from the Utah-400 and set it aside.

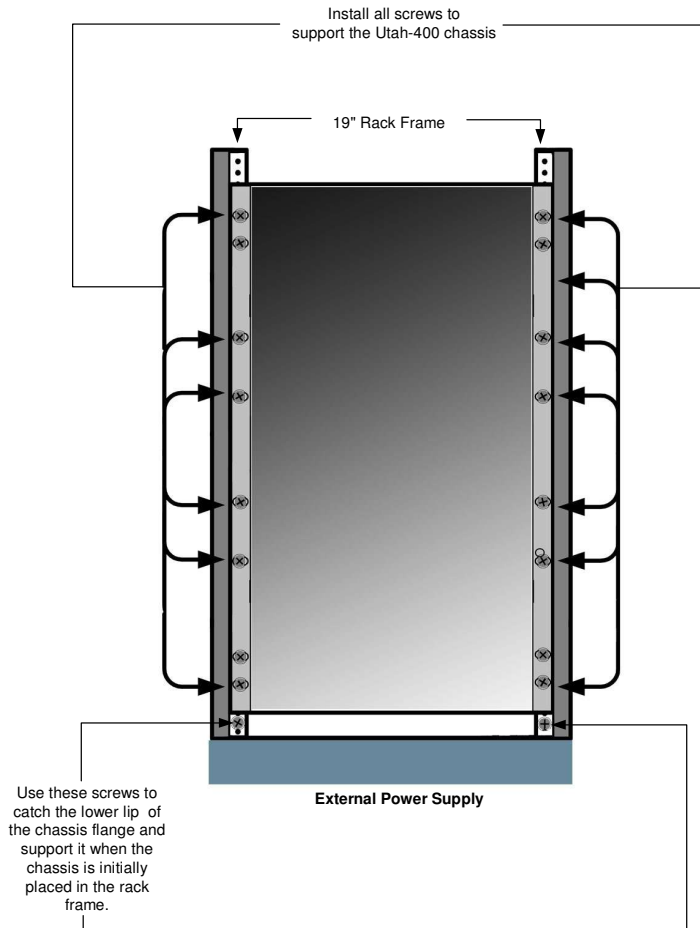

**FIGURE 2-20. Utah-400 Chassis Mounted in 19" Rack Frame**

3. Remove the shipping braces and set them aside.
4. Install the Utah-400 chassis' in the 19" rack frame.

**Note:** *Utah Scientific recommends a minimum of two persons, preferably three, to install the chassis in the rack frame. Install all mounting screws in the front of the chassis; the entire weight of the router and cables are supported by the chassis side-frames.*

- a. Determine the height to mount the Utah-400 in the rack frame.
- b. Install two rack screws 3/4 of the way into the empty rack frame below the height determined in step a, above (leave a 1/8" gap). These screws will be used to support the weight of the chassis when it is moved into the rack frame. See 2-22 "Lowering the Utah-400 Chassis on the Rack Screw," on page 2-20.
- c. With two persons, pick the chassis up from the shipping carton at the left and right side frames.
- d. Move the chassis to the 19" rack frame and carefully slide it into the rack frame, hooking the flange of the chassis above the rack screws installed in step b., above 2-22 "Lowering the Utah-400 Chassis on the Rack Screw," on page 2-20.

**Note: An alternative method is to support the Utah-400 Chassis with a shelf or similar support and align the mounting holes accordingly.**

- e. With the chassis resting on the lower rack screws, carefully lift the left side frame, align the lowest chassis frame mounting hole with a rack frame threaded hole and start rack screw. Repeat for the right hand side frame.
- f. Once the lower chassis rack screws are in place, snug both sides up, but do not tighten.
- g. Align remaining mounting holes, install remaining rack screws through mounting holes, then snug them down.
- h. Finally, tighten all rack screws installed in the chassis mounting holes.

5. Replace all front covers when the installation is complete.

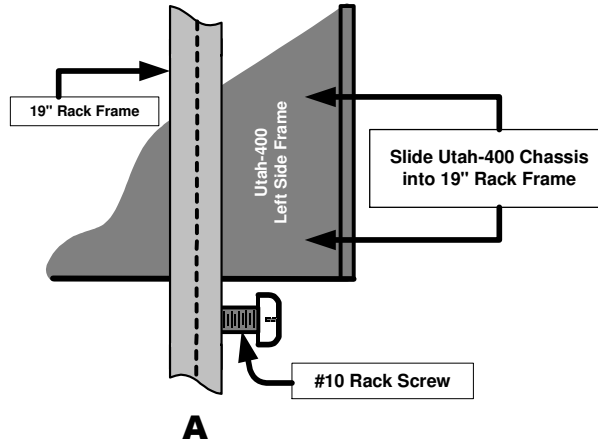

FIGURE 2-21. Sliding the Utah-400 Chassis into Rack Frame

---

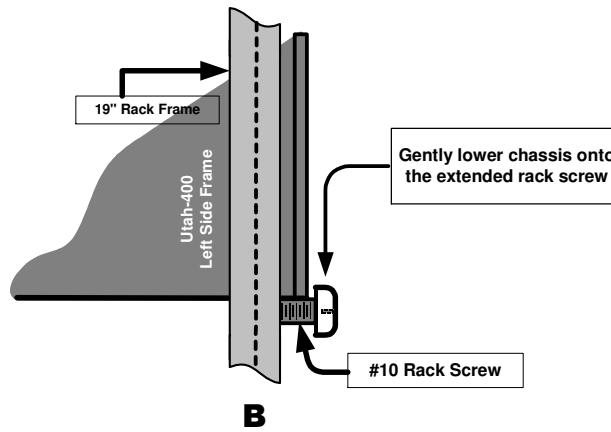

FIGURE 2-22. Lowering the Utah-400 Chassis on the Rack Screw

---

---

### *Installing the MX-Bus Cables*

The Utah-400 routing system utilizes the MX-Bus control system. It must be connected to the SC-4 control system to switch its inputs and outputs. In addition, the proper levels and offsets must be set on the Utah-400 routing system(s) so they will operate on the proper signal levels.

The MX-Bus is a daisy chain configuration, must not exceed 300 feet (91.4 meters) in length; and must be terminated at both ends of the daisy chain.

Your Utah-400 router is shipped standard with:

- One MX-Bus Cable – 10 ft. (USI Part Number: 80229-10). Other lengths are available and may be ordered through Utah Scientific sales at 1-800-453-8782.

### Interconnecting the SC-4 and Utah-400 Frames

The MX-Bus interconnection to the Utah-400 typically starts at the SC-4 control system and is terminated at the last physical Utah-400 chassis. The actual physical arrangement depends on the site placement of the various physical components.

The following illustration shows a typical MX-Bus installation.

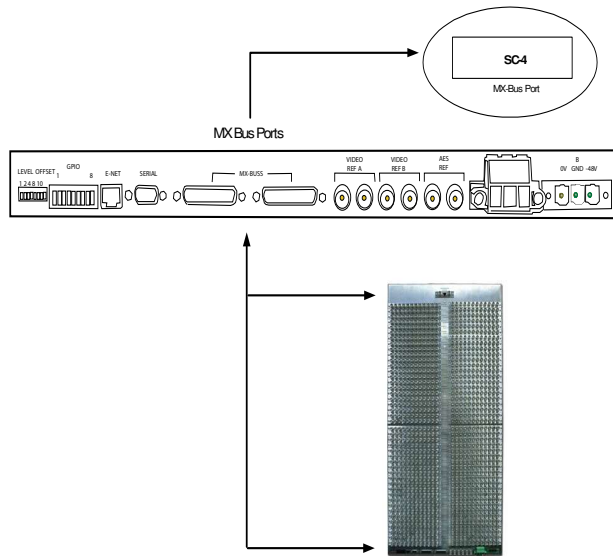

FIGURE 2-23. The MX-Bus Installation to an SC-4 Controller

**Note:** The XL frame contains two identical connections; top and bottom. Both must be cabled as if they were individual frames.

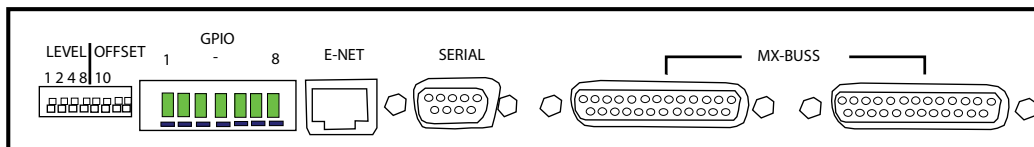

FIGURE 2-24. Control Backplane

The following illustration is a block diagram showing the Utah-400 in an MX-Bus daisy chain with other Utah Scientific equipment.

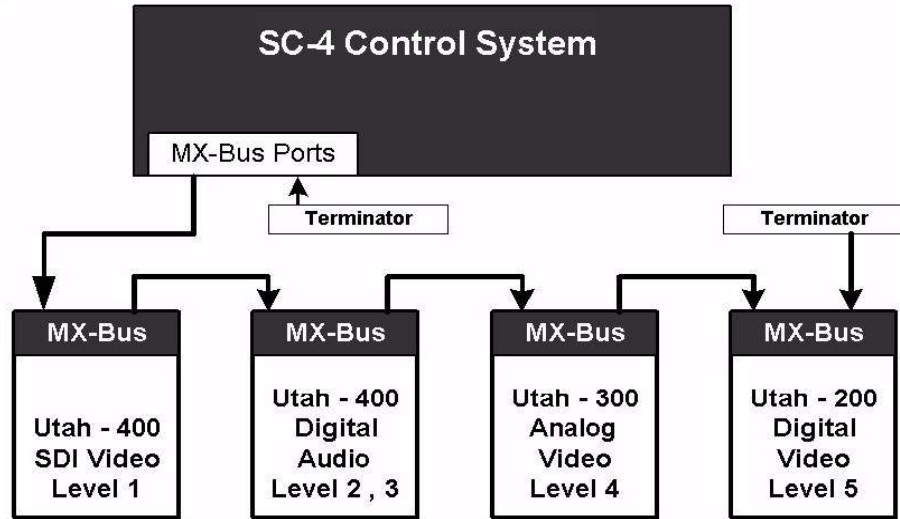

FIGURE 2-25. Block Diagram of the MX-Bus Daisy Chain.

---

## Connecting the AES Reference Signal

In systems that contain any audio components such as AES or Analog audio IO, a TDM crosspoint submodule, or Dis-embedding input cards, and AES reference is required in order to allow the system to process that audio signals correctly.

On the router Frame Controller Module, a Time Base submodule will be installed for these types of systems to receive and process the AES reference. The Frame Controller Module will generate an alarm if the Timebase Submodule does not detect an appropriate reference signal.

The signal type is AES3-id DARS, or another AES3-id signal that is generated from the plant signal generator, and to which all other audio signals are locked.

Crosspoint based Series 2 routers will route Asynchronous signals, but TDM based systems require that all incoming AES signals be locked to the same signal as is applied to the AES Reference BNC's.

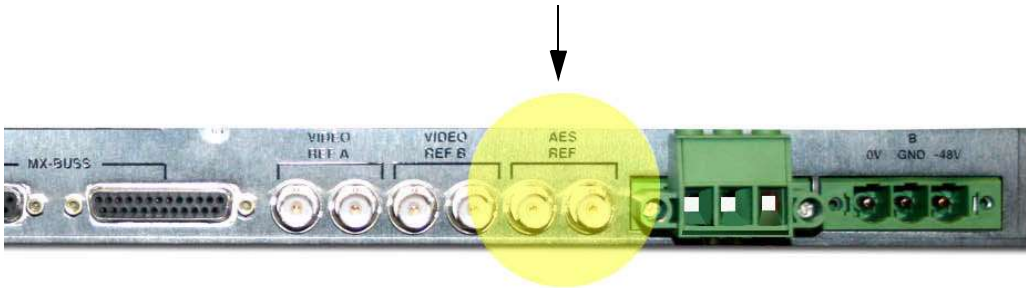

FIGURE 2-26. AES Reference

---



## **Determining and Setting Router Signal Levels**

Signal levels are preset at the factory and tested during manufacturing, determined by customer input and requirements. The installation of your new Utah-400 Router should not require any signal level changes to operate after the new installation.

By definition, a signal level represents distinct elements of the broadcast system. These individual elements include, but are not limited to, High Definition Video, SDI Video, Digital Audio, Analog Video, Analog Audio and Data Routers. For additional information relating to signal levels, refer to “Signal Levels,” on page 1-8.

### *Switch Settings*

Should you ever need to change the signal level of your router it is useful to determine:

- What new signal level is required.
- If other signal levels will have to be modified to accommodate the new signal level.
- Additional encoding requirements necessitated by the change.
  1. Locate the dip switch on the control I/O panel at the rear of the chassis.
  2. The four level bits work in a binary addition mode. Possible values range from 0 (all down) to 15 (all up). 0 is level 1 in an SC-4 control system, and 15 is level 16.
  3. Set the switches to the level you have chosen according to the following table.

Switch	1	2	4	8	Binary Value	SC-4 Level
	OFF	OFF	OFF	OFF	0	1
	ON	OFF	OFF	OFF	1	2
	OFF	ON	OFF	OFF	2	3
	ON	ON	OFF	OFF	3	4
	OFF	OFF	ON	OFF	4	5
	ON	OFF	ON	OFF	5	6
	...	...	...	...	...	...
	ON	ON	ON	ON	15	16



### *Unlabeled Dipswitch Positions*

The last two dipswitch locations must be down in all cases, with the exception of an XL router. In that case, the lower chassis has the left switch up and the right switch down, and the upper chassis has both switches up.

## Offset Switch

The offset switch allows you to provide a base offset to the router; containing inputs, outputs, or both. This applies when multiple routers are to be 'stacked' on the same level, or when multiple router frames are placed in a larger matrix.

To offset the inputs by 528 inputs, move the '1' dipswitch up. To offset the outputs by 528, move the '0' dipswitch up. The figure below displays the settings within a 1056 router.

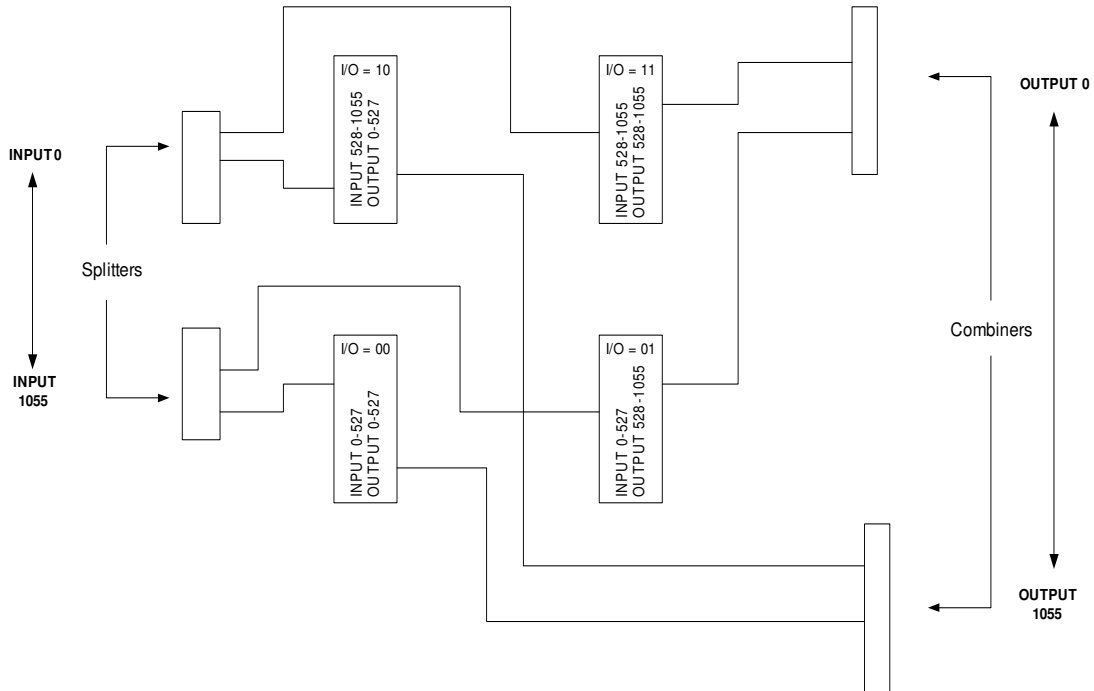
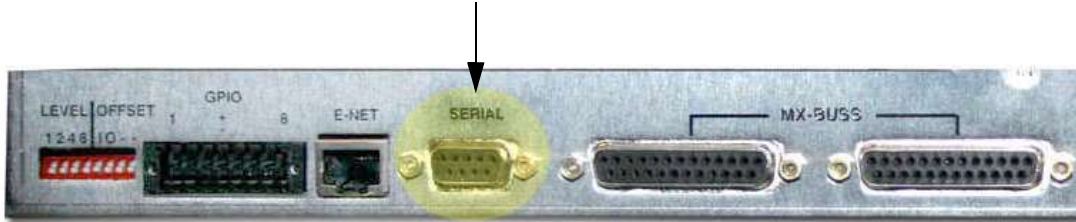

FIGURE 2-27. Offset switch configuration

---

## Serial Port

This is a RS-232 DTE port, and is used as for diagnostic purposes. A terminal emulation program such as Tera Term is used for communication.



### *Baud Rate Information*

Baud	38400
Data Bits	8
Stop Bits	1
Parity Bits	N
Handshake	XON/XOFF
Output Translation	CR = CR/LF

### *Pinout Information*

Pin	Signal Name	Direction
2	Receive Data	In
3	Transmit Data	Out
7	RTS	Out
8	CTS	In
5	Ground	

## Ethernet Port

The 10/100 ethernet port is used as a diagnostic and monitoring port. Connect this to a standard ethernet network.



## GPIO Port

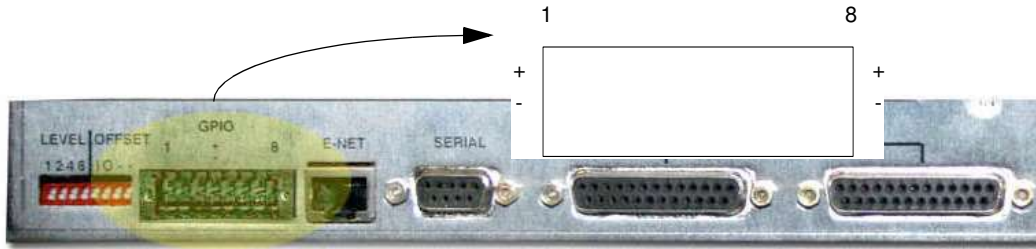

The GPIO block provides the following functions:

GPIO#	Direction	Function
1	INPUT	Indicate Power Supply Failure
2	INPUT	Unconnected (TBD)
3	INPUT	Controller Changeover
4	INPUT	Crosspoint Changeover
5	OUT	SMPTE Alarm
6	OUT	TBD
7	OUT	TBD
8	OUT	TBD

To activate a GPI input, short the + and - leads together.

When the SMPTE Alarm is active, there will be a short circuit across the + and - pins.

***Note that with FCM (Frame Controller Module) software version 1.2.0 and above, you can change the EXTERNAL Power Supply Failure GPIO (1) Polarity by using the menu item 'P' from the FCM serial menu.***

## Installing the Video/Unbalanced Digital Audio Input & Output

This section provides guidelines for installing the Utah-400 Video Inputs and Outputs on the backplane connectors. Serial Digital Video and Audio cable specifications are listed below.

Input Signal	Recommended Cable Type	Maximum Cable Length	Termination Method
Digital Video and Unbal. Digital Audio	Belden 8281	300 M. / 1000'	Internal - 75 Ohm
High Definition Digital Video	Belden 8281	100 M. / 300'	Internal - 75 Ohm
	Belden 1694A	150 M. / 500'	Internal - 75 Ohm
	Belden 7731	200 M. / 600'	Internal - 75 Ohm
3G Digital Video	Belden 1694A	100M	Internal - 75 Ohm
	Belden 7731	120M	Internal - 75 Ohm

The following recommendations are made regarding cable connections:

- Ensure the router frames are installed securely in the equipment racks.
- Due to the compactness of the Utah-400 rear panel BNC's, it may be useful to have a connector chart next to the backplane.
- The use of a BNC insertion / extraction tool is recommended.
- Label the Input and Output cables coming into the rear panel – for example:
- VTR1 – Video Out or Out 0 – VTR1.
- All Utah-400 Digital Video/Unbalanced Audio BNC's use 75-Ohm single ended connectors.
- Avoid stress on the lower backplane BNC connections by providing proper strain relief on all cables.
- The Utah-400 Input matrix starts with Input 0 at the top right of the backplane.
- The Utah-400 Output matrix starts with Output 0 at the bottom right.
- Due to the 75 Ohm internal termination, do not use BNC "T" connectors to loop an input signal. This will result in serious signal degradation.

Figure 2-28 on page 2 -32 shows the entire Utah-400 528 x 528 Matrix rear panels. (Video or unbalanced digital audio.)

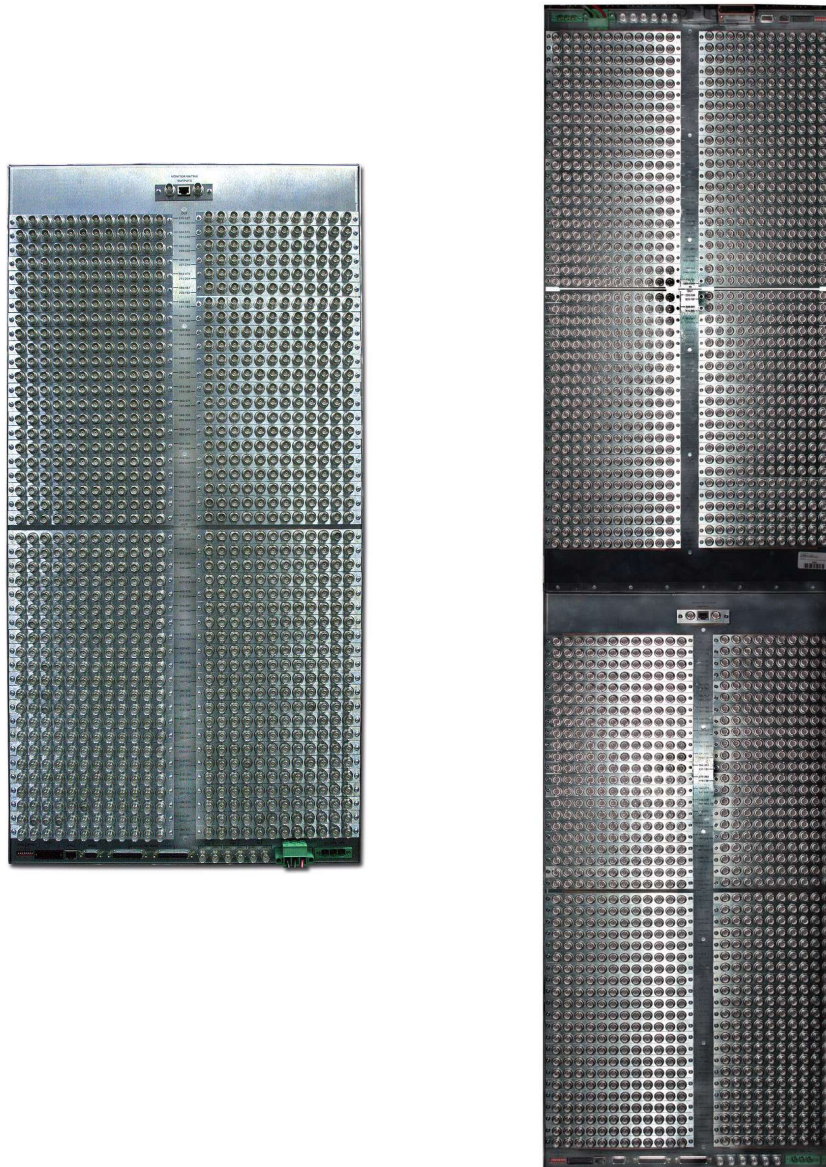

**FIGURE 2-28. Utah-400 528<sup>2</sup> and XL Video Unbalanced, or Audio Rear Panel**



### *Installing the Analog Audio Input and Output Cables*

The following recommendations are suggested for installing the Analog Audio Inputs and Outputs.

- Ensure the Utah-400 Chassis are installed securely to the equipment rack.
- Label all cables going to the Inputs and Outputs, for example:
  - **Inputs 0-7: VTR1 – 0, VTR2 – 1, SAT –4 ...**
  - **Cable-1; Inputs 0-7, see Chart 1....**
- Pre-wired cables are available from Utah Scientific.
- D-connector to terminal block. Breakout panels are available from USI. (BDA-400)
- Inputs and Outputs can be connected directly to the backplane using 37 pin high-density "D" connectors and back shells. (Supplied with the system) Contact Utah Scientific sales for more information.
- Additional strain relief should be provided for each "D" connector, in addition to the connector screws.

Refer to *Chapter 4, Utah 400 Components* for wiring charts and a list of audio connector suppliers.

---

## *Connecting and Disconnecting Power*

The power system within the Utah-400 Series 2 router consists of two -48V power feeds present at the lower end of the chassis, and are fully isolated redundant feeds to each individual module (input card, output card, crosspoint card) within the system.

With this architecture, there is no power supply assembly internal to the chassis itself, as each module receives and converts the -48V bus to its own internal requirements. Overall power consumption depends upon loading, but an average fully loaded system consumes 1300 watts for a 528 system, 600 Watts for a 288 system, and 300 Watts for a 144 system. The 72x72 router contains internal supplies, while the XL routing system is treated as two separate 528 routers from a power supply standpoint.

The standard power supply assembly shipped with a router (that is to be powered via AC mains) contains four rectifier modules for a 528 system and two rectifiers for a 288 or 144 system. Each rectifier is capable of providing 1000 watts of 48V output power. These systems are load sharing and N+1 redundant, so a 528 router can run off of any 2 rectifiers, and the 288 or 144 routers off of any 1 rectifier. If only a single external power supply system is used, it should be connected to the 'A' power supply port.

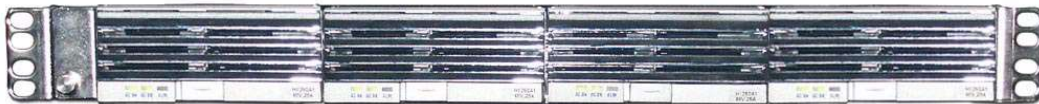

**FIGURE 2-29. Power Supply (front view)**

From the power supply assembly, three 6 GA wires carry power to one of the two 48V power feeds of one half of the 528. Two of the wires (White and Red) connect together at the topmost (positive) output post of the power supply assembly and connect to GROUND and OV respectively of the 528.

---

## Connecting and Disconnecting Power

---

The black wire connects to the lower (negative) output post of the power supply and passes through a 40A fuse prior to connecting to the -48V input of the router. This fuse is a Littlefuse part number 142.6885.5402, or USI part number 41913-0001.



**FIGURE 2-30. Power Supply cable assembly (rear view)**

---

If a higher level of redundancy is desired, a second power supply assembly can be purchased and connected to the 'B' 48V input port. This provides an additional level of redundancy inside the router frame, as every module can now take voltage from the A or B bus, and each of those busses is fed by a redundant power supply system.

If the system is to be powered by a -48V facility power supply system, the user can feed either the A or B power busses, or both. 6 gauge wiring is recommended and a system capable of supplying 30 Amps for the 528 router, 15 Amps for the 288, and 10 Amps for the 144 is recommended. The connection is a DC-I isolated connection. The Ground pin of the 3 pin connector is chassis ground, the 0V connection is the most positive leg of the -48V input, and the -48V connection is the most negative leg of the -48V connection. The mating connector is Phoenix Contact 1913581, USI part number 41258-1014.

## DC Connectivity

The 528 and XL routers do not contain internal power supplies or AC connections. Each card in the system receives 48 VDC from two external power supply connections.

- Ground - Frame or chassis grounding point
- 0V - Most positive leg of -48V DC connection.
- -48V - Most negative leg of -48V DC connection.



***Note that this configuration is a DC-I or DC isolated connection.***

The terminal strip is a small bracket containing three screws (see 1). Loosen the screws to remove the terminal from the back. This will expose the strip of wire (aprox. 1/4 of an inch).

### *Proper wire insertion into the removable terminal block*

- Turn the screws counter clockwise to allow wire insertion (3 screws on block top).
- Strip 1/4" of the insulation from the new wires.
- Insert wire, then turn screw clockwise to tighten

When installing the cable, the white and red wire connect to lugs on the Positive (upper) connector on the rear of the Valere chassis, and the black wire connects to the negative (lower) connector. On the rear of the UT4-528 or XL, the red wire connects to 0V, the white to ground, and the black to -48V.

*Use 10 AWG wire (minimum)*

The maximum current required for the branch circuit feeding the UT-400 XL and UT-400 528 is 35 Amps. An XL system requires two external power supplies, one for each half of the system.

---

## Pre Power-Up Checks

Before applying power to the router, check the following:

- All boards within the router must be fully seated; not crooked or outside the card guides.

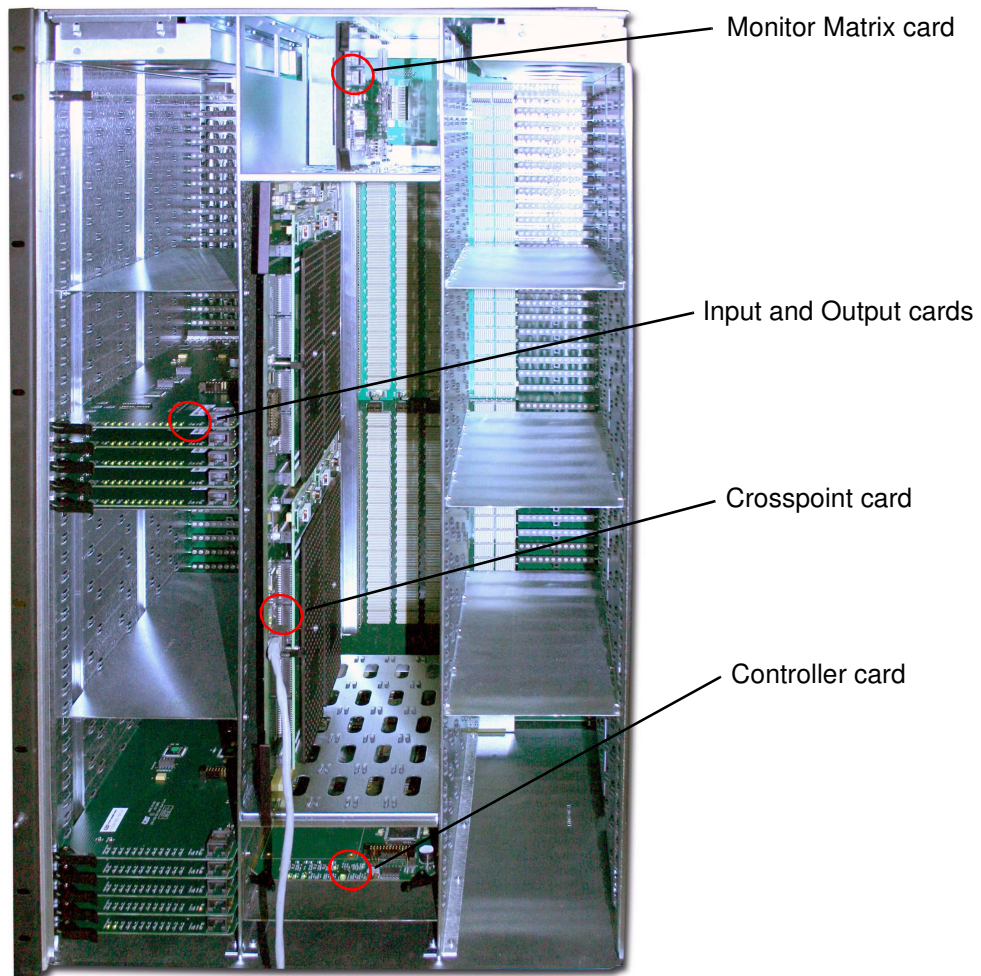

FIGURE 2-31. Power On LEDs

---

### Initial System Power-Up

After verifying AC and DC power connections, apply power to the system. Verify that the following system indications are present.

1. All Chassis fans are turning, and all eight LEDs are green.
2. The AC and DC power OK LEDs on the external power supply are on.
3. The green Power OK LEDs on the crosspoint cards are on.
4. No red LEDs are present on the I/O cards.
5. The large green LED on the Frame Communication module is on.

If one or more of the indicators are not present, remove power and re-check the connections. If the problem persists, contact customer service.

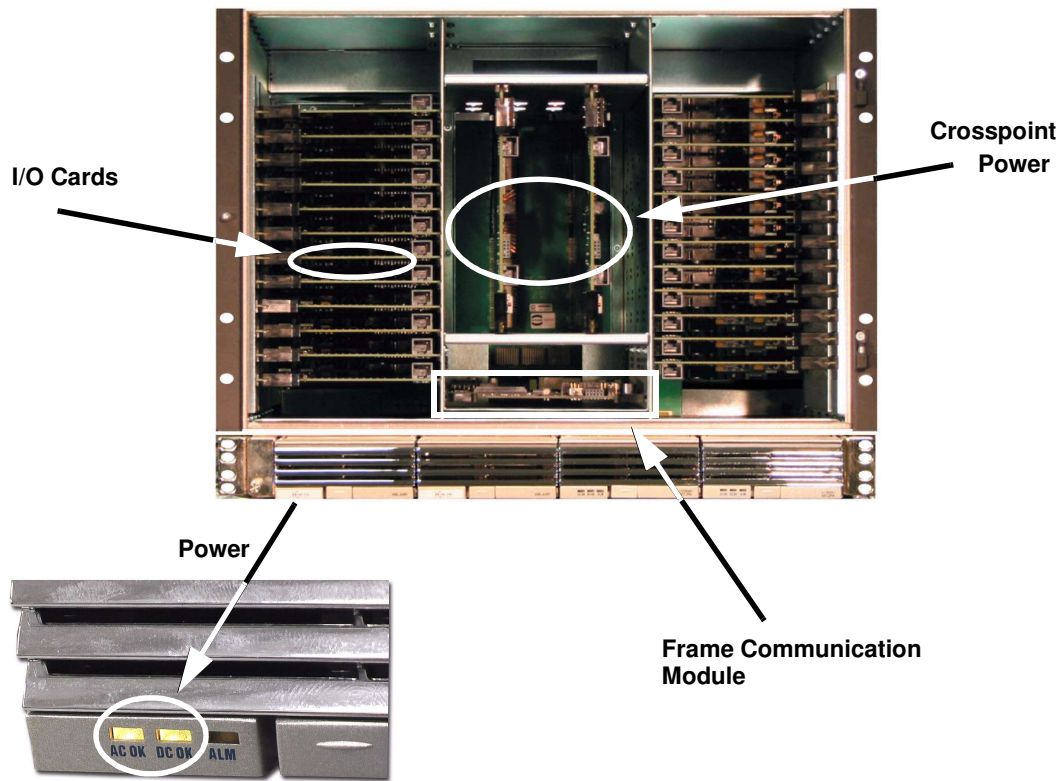
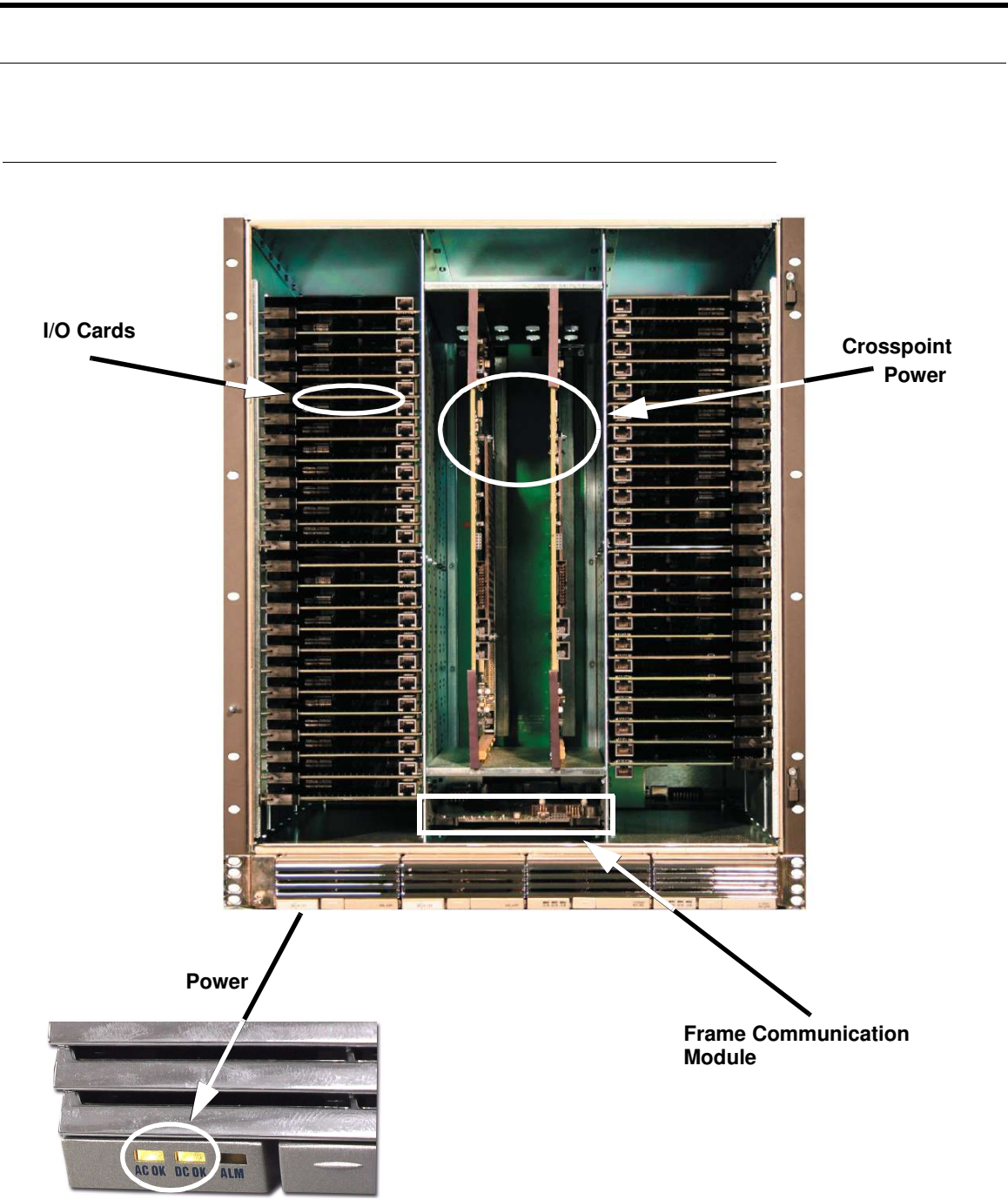

FIGURE 2-32. 144 Systems



**FIGURE 2-33. 288 Systems**

---

## *UTAH-400 Series 2 - 72x72 AV Router*

### **Overview**

The UTAH-400 Series 2 - 72x72 AV Router is the smallest member of the UTAH-400 Series 2 line. This router utilizes all of the same audio and video input, output, and rear panel cards as the rest of the Series 2 line, but with some significant differences from the other systems.

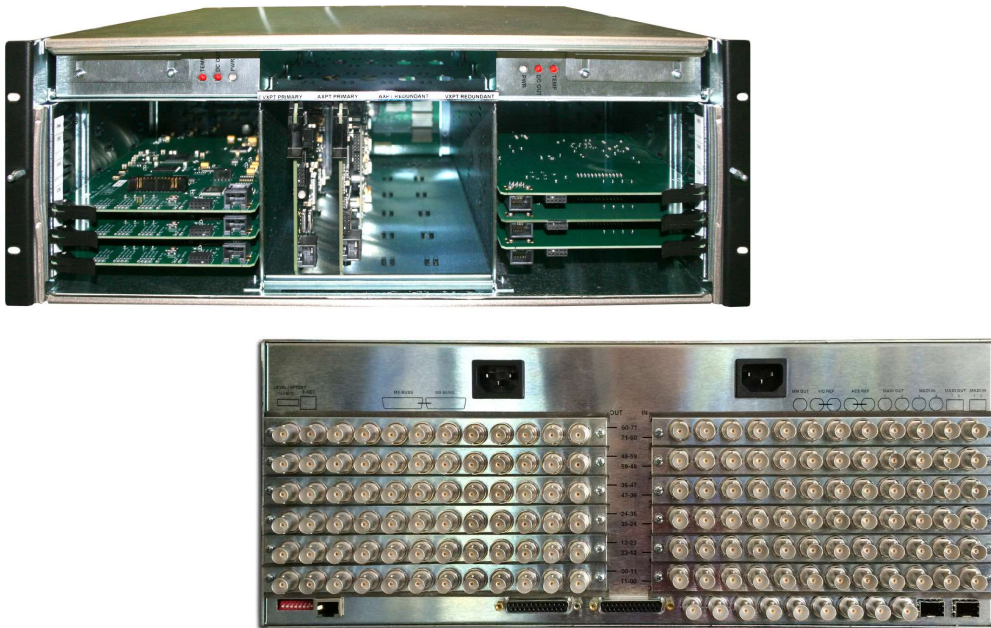

**FIGURE 2-34.**

The 72x72 AV router contains two internal AC to -48V power supplies for system power provision, with each supply feeding a separate -48V input on the cards in the system. Full redundancy is accomplished with separate power rails inside the frame, with only one supply required to run a fully loaded system.

Unlike the other Series 2 routers, this router does not contain a Frame Controller Module card. Instead, the FCM functionality is built onto the video crosspoint cards. This functionality includes monitoring of the local boards, power supplies and temperature, reporting the results to rMan. Note that even if no video switching is desired (e.g. audio router only), at least one video crosspoint card must be installed to serve the FCM function in the router.



The 72x72 AV router contains two slots for video crosspoint cards; a primary and a redundant, and two slots for audio TDM crosspoint cards (primary and a redundant). There are two types of video crosspoint cards; the 121337-1 Deluxe crosspoint card and the 121337-2 basic crosspoint card. The basic crosspoint card contains a 72x72 crosspoint chip, while the Deluxe crosspoint card contains a larger 144x144 crosspoint chip, allowing the system to run as a rectangular array rather than square. With the Deluxe crosspoint, the system can be configured to run as a 12 in by 132 out, or a 132 in by 12 out, or any mix in between. The 72x72 router also contains a Video Monitor Matrix that is integral to the Video crosspoint card with an optional H.264 streaming output of this monitor matrix.

Audio switching within this system is accomplished with a redundant pair of 121338-1 audio crosspoint cards. These cards carry the standard 121285-1 Audio Timebase Module and 121295-1 TDM Audio Crosspoint Module to generate system references and perform crosspoint switching.

When installed, audio crosspoints respond directly over the MX bus to the SC4 controller, reporting their part number and the status of the audio reference. This card also contains two native MAD I input and output ports that are fed directly into the TDM crosspoint on port 6 (IO's 1536-1663). The card's default configuration is to accept TDM audio streams from its 6 input card slots, the onboard MAD I, and the last 5 TDM audio signals from the BNC's for inputs (67-71). The input side can be modified with all inputs coming from the video BNC's (60-71).

The 72x72 AV router drives its local output cards on ports 0-5; the local MAD I on port 6, and output BNC's to 60-71, with another copy of ports 0-11.

### **Rear Panel Interconnect**

The 121334-1 UT4S2 72X72 CNTRL I/O PCA card is the location at which the external MAD I, MX Bus, and other control signals interconnect to the frame. This card also contains the level setting dipswitch for the system. Note that the video crosspoints are on the level indicated by the dipswitch; the audio crosspoints on that level + 1, (the convention for the TDM audio routers in other UT400 frames). The 12 IO card slots are loaded with all required rear panels for the system.

### Hardware Checkout

Use the following flow chart to check out your Utah-400 System. Note the following important points:

- For the Video and Audio System columns may be switched numerically if encoding is not required.
- For the System Control column, the SC-4 Control system may require some configuration in order to perform all functions.

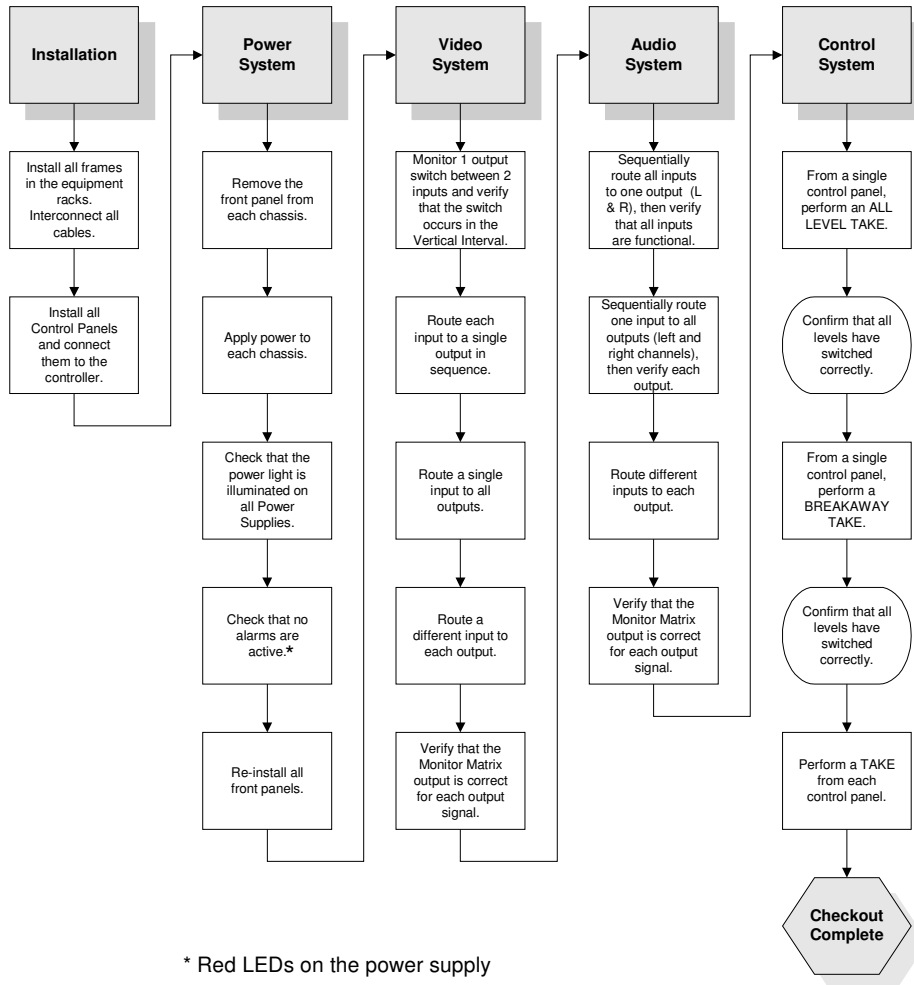

# *Configuration and Operation*

---

This chapter provides an explanation for specific Utah-400 configurations, and basic instruction for the handling and operation of your Utah-400 system.

---

## *In This Chapter*

Utah 400 SC-4 Control .....	3-2
Chassis Types .....	3-4
Operation .....	3-10
Alarm Indication .....	3-10
Ethernet and RS-232 Connection .....	3-11
Crosspoint Cards Maintenance .....	3-11
Input and Output Card Removal .....	3-12
Crosspoint Card Removal and Replacement .....	3-12
Air Dam Removal and Maintenance .....	3-13
Fan Service .....	3-14
Power Supply .....	3-15
External Power Supply .....	3-15

Utah 400 SC-4 Control

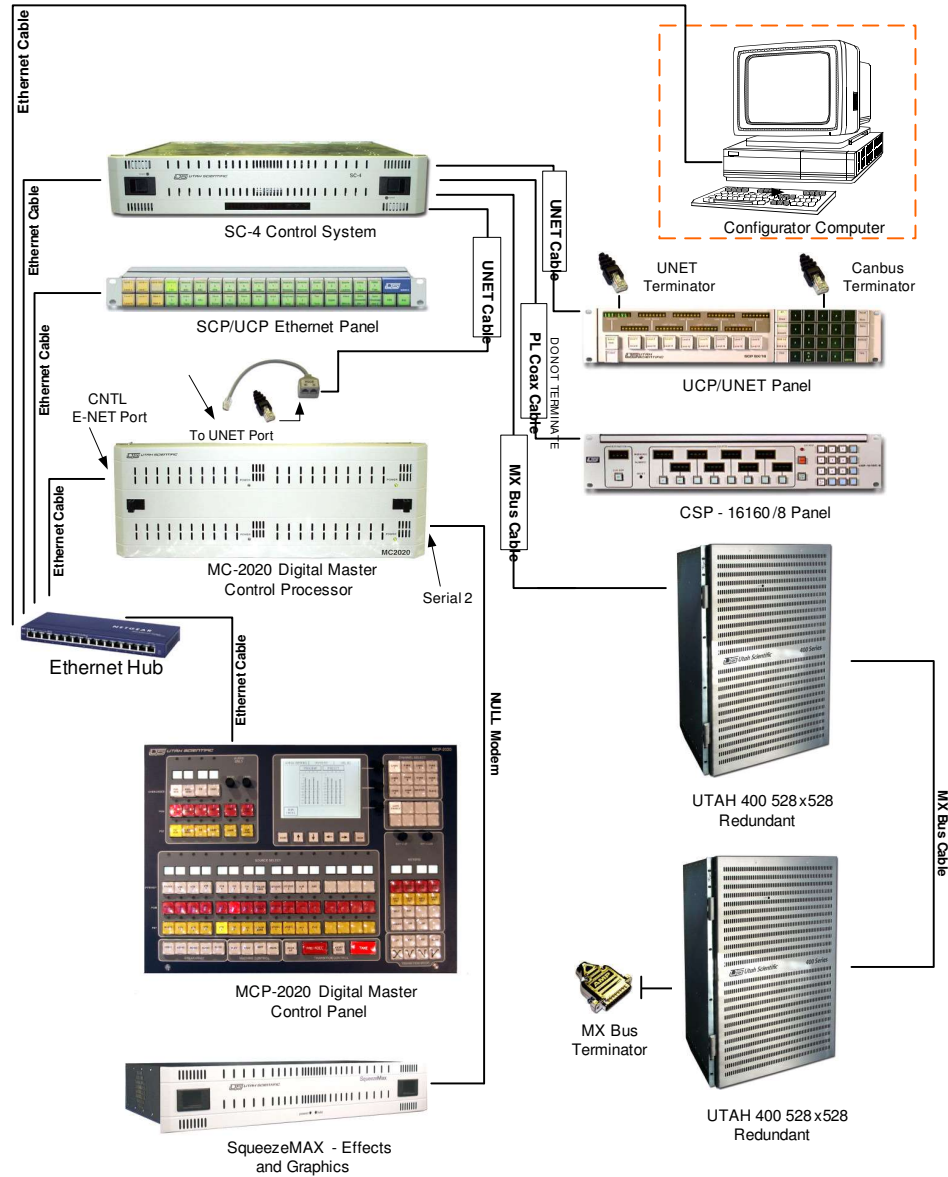

TABLE 2-1. SC-4 Configuration for the Utah-400 and MC/MCP-2020

<b>SC-3/4 System Cable / Termination Table</b>			
<b>Part Name</b>	<b>Part Number</b>	<b>Description</b>	<b>Comments</b>
UNET Terminator	65324-04	8 RJ-45	Supplied by USI
MX-Bus Terminator	70797-1	DB-25P Module	Supplied by USI
MX-Bus Cable	80229-010	Parallel / DB-25P	Supplied by USI
UNET Cable	N/A	UTP/RJ-45	Not Supplied
Ethernet Cable	N/A	UTP/RJ-45	Not Supplied
Party Line Coax Cable	N/A	<b>Belden RG-59/U; 9209 or 8281</b>	Not Supplied

---

*Chassis Types*

**72x72 Front and Rear Views**

FIGURE 3-2.

---

**72x72 System Layout**

Power Supply 1					Power Supply 2
Input Card 60-71, Output Card 72-83	Primary Video XPT	Primary Audio XPT	Redun Audio XPT	Redun Video XPT	Output Card 60-71, Input Card 72-83
Input Card 48-59, Output Card 84-95					Output Card 48-59, Input Card 84-95
Input Card 36-47, Output Card 96-107					Output Card 36-47, Input Card 96-107
Input Card 24-35, Output Card 108-119					Output Card 24-35, Input Card 108-119
Input Card 12-23, Output Card 120-131					Output Card 12-23, Input Card 120-131
Input Card 0-11					Output Card 0-11

**FIGURE 3-3.**

The system is capable of being loaded in a variety of ways as displayed in the above illustration. From a video centered standpoint with the basic 121337-2 Video Crosspoint card installed, the left hand 6 slots can be loaded with SDI input cards, while the output side is loaded with SDI output cards, creating a generic 72x72 router. If the 121337-1 is used, the first input card slot must be an actual input card and likewise, the first output card slot must be an output card, but the other 10 IO card slots can be loaded with any other combination as required.

The following applies when adding the TDM Audio crosspoint to the system; IO options include embedder and disembedder cards, MAD1 IO cards, and analog and digital audio cards.

***System Control Functionality***

The video crosspoint card pair is responsible for monitoring all of the devices in the system and making decisions based upon their status. The card pair gathers information from the IO cards and power supplies and determines whether or not to set alarms or update the information provided to the SC4 controller. It also communicates with the audio crosspoint cards and decides which one of the two will be the primary card.

All of this communication is done over 4 separate control busses in the system, which are isolated to guard against single failure points.

144 Front and Rear Views

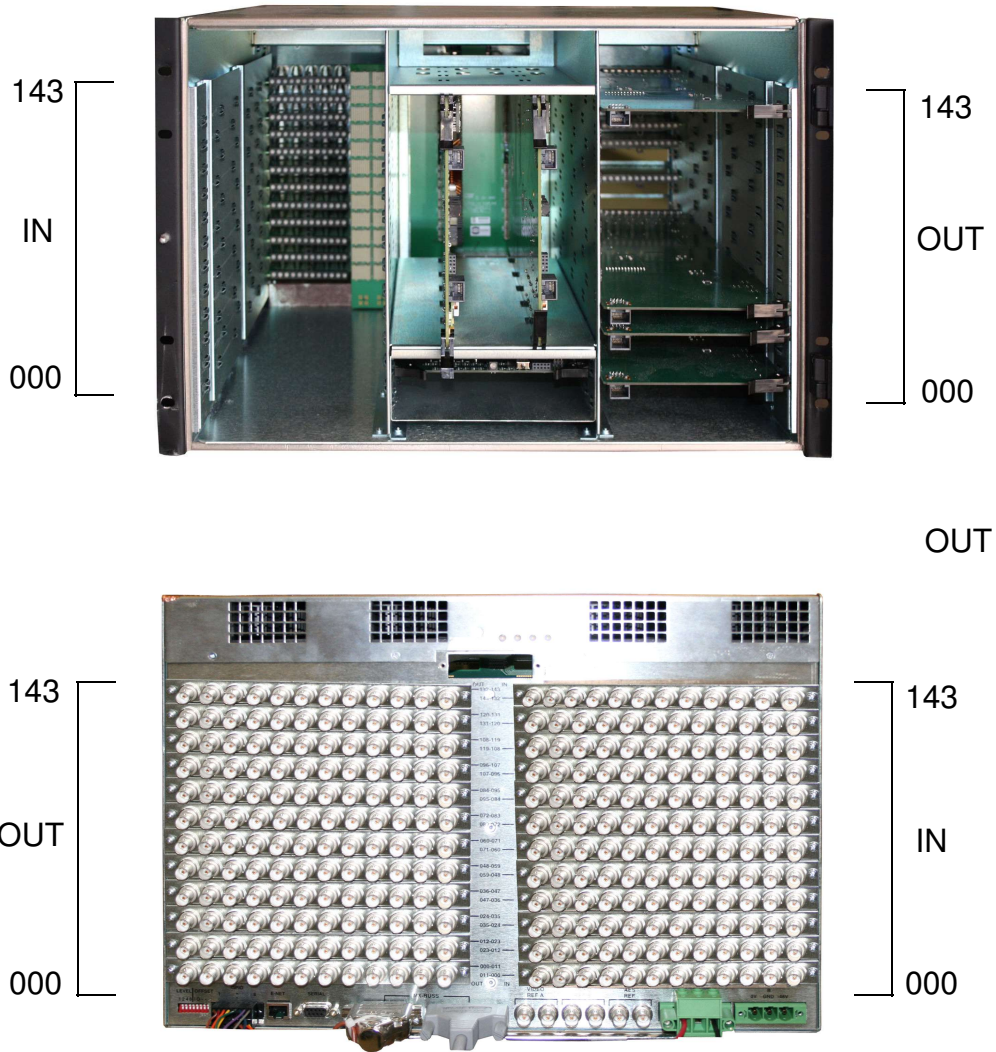

FIGURE 3-4. Interior (pre-module) and rear view - 144 System



288 Front and Rear Views

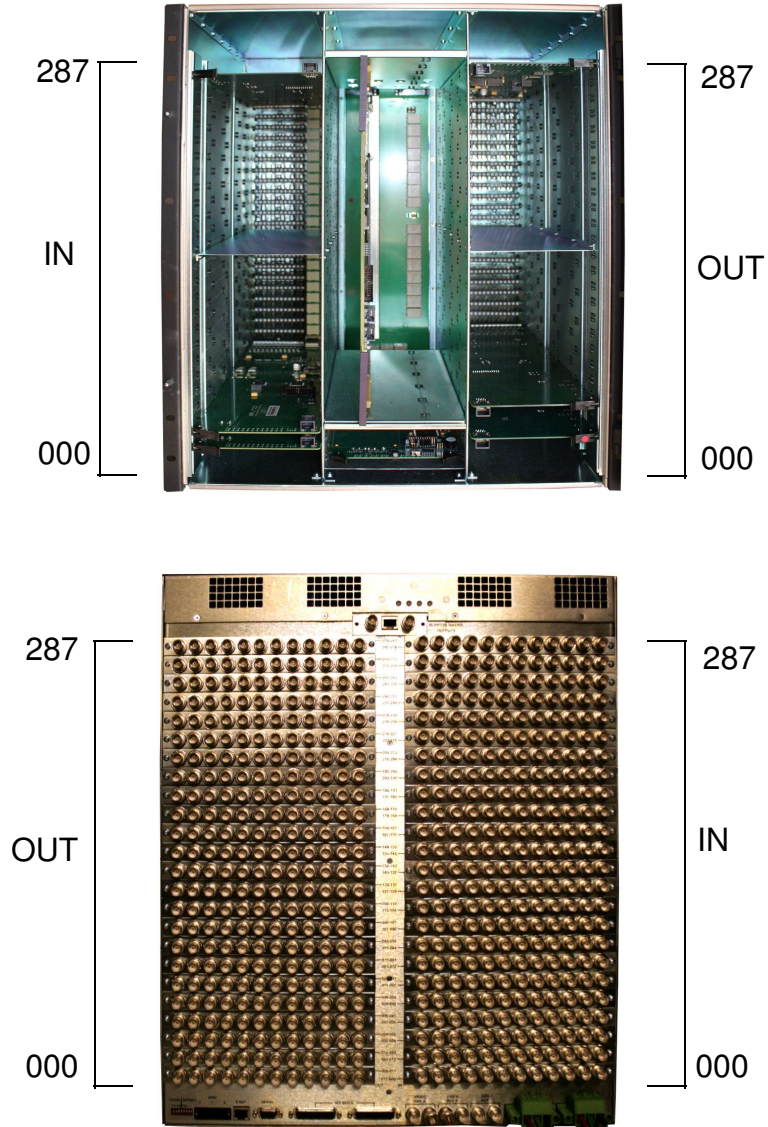

FIGURE 3-5. Interior (pre-module) and rear view - 288 System

### 528 Module Array

There are 22 slots containing the input modules within the router's lower left and right sides. Input 0 is located at the bottom, while inputs 263 and 527 are at the top of the array. The 22 output slots are placed on the upper left and right, with outputs 0 and 264 located at the bottom, and outputs 263 and 527 positioned at the top (upper array).

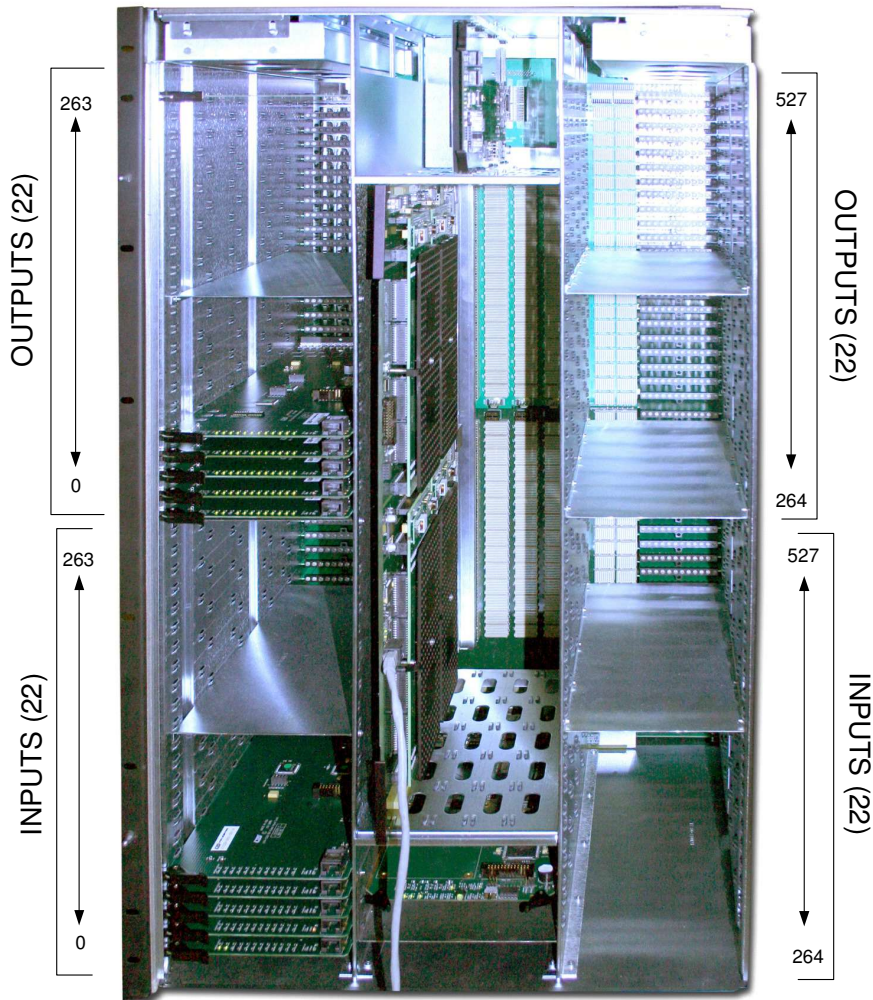

FIGURE 3-6. Module Array - 528 System

400 XL Module Array

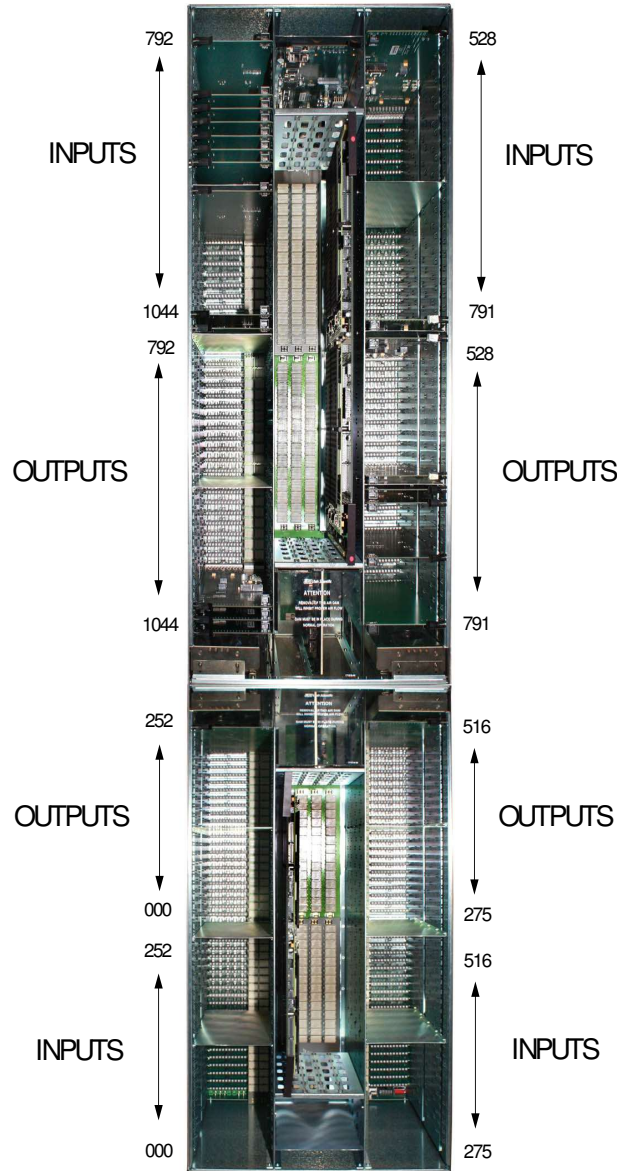
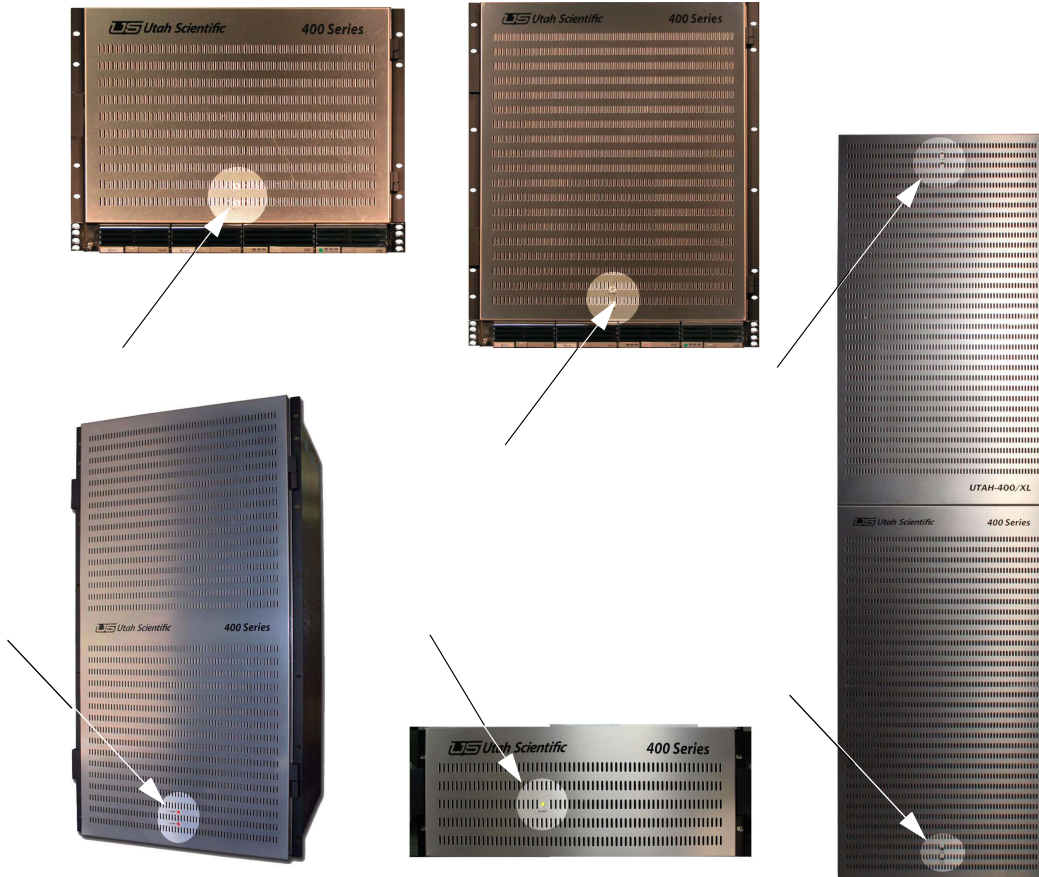

FIGURE 3-7. Module Array - XL System

## Operation

### Alarm Indication

The alarm LED located on the front of the UT-400 chassis is a universal indicator, and will illuminate when any alarm condition is sensed.



**FIGURE 3-8. Router Alarm Indication - 144, 288, 528, 72x72 and XL chassis**

The SMPTE alarm port is used to generate contact closures indicating a problem within the system.

## Ethernet and RS-232 Connection

The Ethernet and RS-232 connections are diagnostic.

## Crosspoint Cards Maintenance

The UT-400 chassis contains two vertical crosspoint cards at the center of the chassis; the leftmost being the primary card, while the card on the right is redundant.

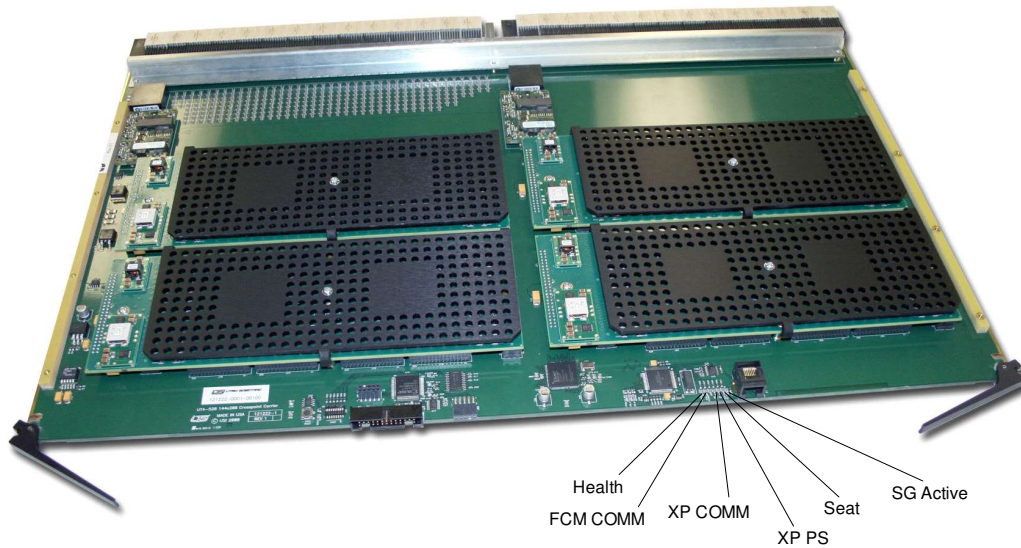

**FIGURE 3-9. Crosspoints LEDs**

---

The crosspoint card's voltage LEDs behave like other UT-400 series displays, with green indicating normal activity and red signaling a problem condition.

The Scangate Activity LED will flash to indicate normal activity.

### *Debug Port*

The software utility associated with the crosspoint card's debug port is currently under development. Please check back.

### Input and Output Card Removal and Replacement

To correctly remove and replace the individual input and output cards, always make sure the guides are located (inside the chassis) and the card slides all the way in before the ejector is locked in place. The card ejectors are pressed inward and down from the card when locking, and pulled outward from the card when removing.

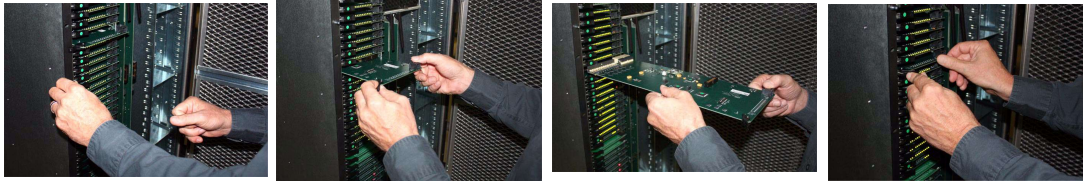

---

**FIGURE 3-10. Input/Output Board Replacement and Removal**

All boards within the Utah-400 system are hot-plug capable.

### Crosspoint Card Removal and Replacement

The Crosspoint card uses a slightly different version of the locking and unlocking mechanism. The board is removed by gently pulling the ejector tabs outward, and locked into place by pressing the two tabs inward.



---

**FIGURE 3-11. Crosspoint Board Removal**

### Air Dam Removal and Maintenance



The Plexiglas air dam covers the fan controllers and monitor matrix cards. It is critical that these components receive proper cooling during normal operation. Make sure the air dam is removed only during periods of needed maintenance.

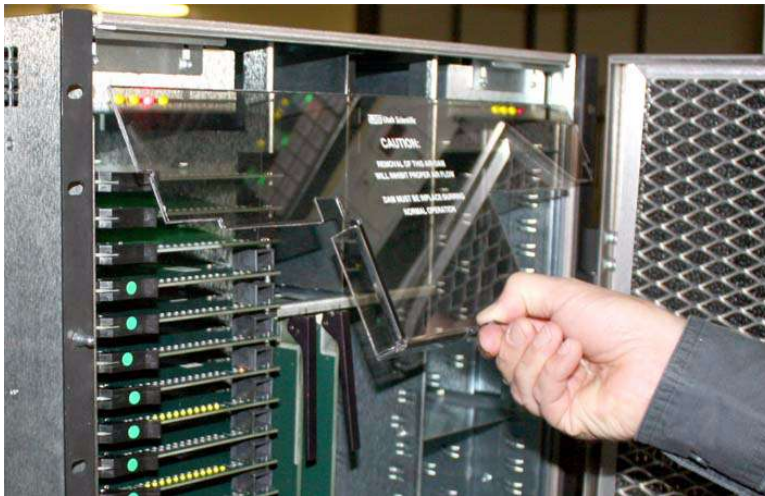

**FIGURE 3-12. Air Dam removal/replacement**

---

In addition to the plexiglass air dam, the IO cards in the uppermost slots on the left hand and right hand side of the chassis are a critical element in the cooling design of the chassis.

Cards **MUST** be installed in these slots. If your system did not have IO cards purchased for these positions, blanks will have been placed in those slots. Ensure that they are not removed for long periods of time.

## Fan Service

Alarm indicators on the crosspoint control card and power supplies will indicate any fan problems.

Individual fan modules can be lifted out by removing the two top screws that hold each in place. The new module is connected by simply aligning each and pushing it in place, then re-attaching the two screws.

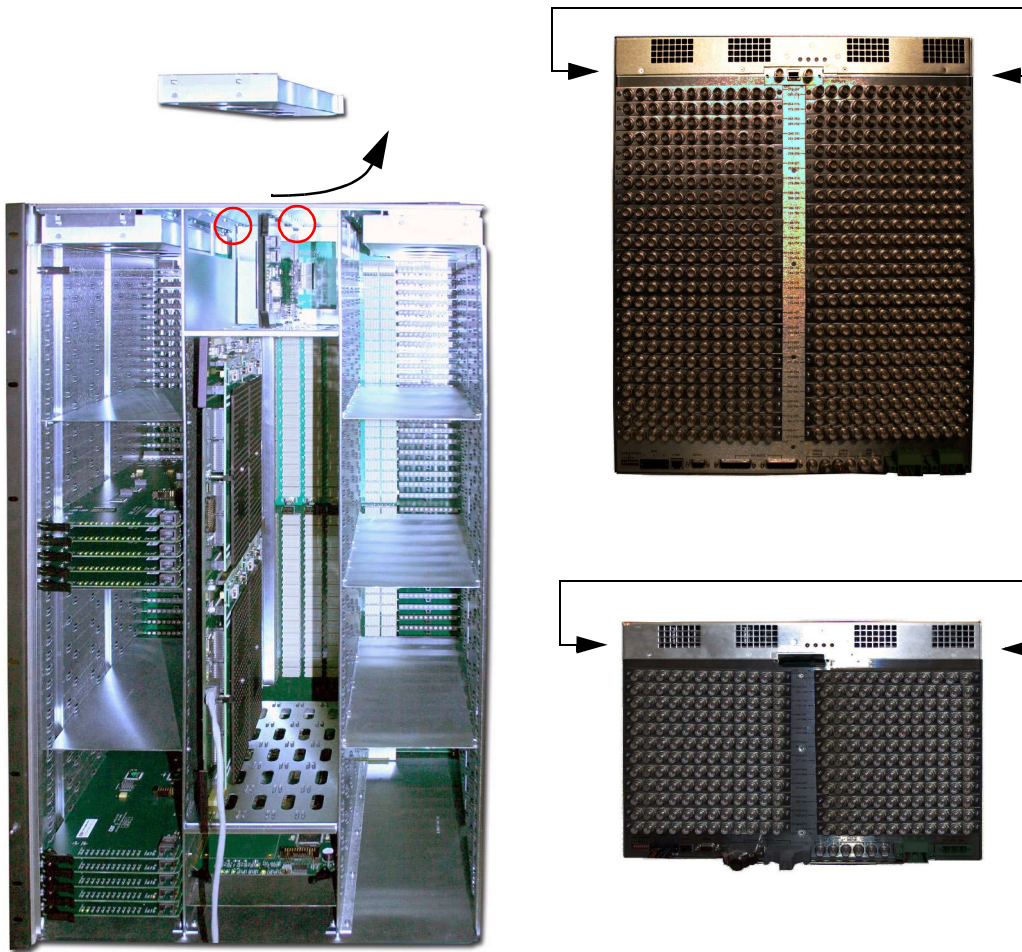

FIGURE 3-13. Fan location and removal



## **Power Supply**

### *External Power Supply*

The power supply interconnects with the router at the bottom of the assembly using a cabled interface. Using Utah Scientific's pre-molded cable assembly, the ground signal and 48 volt conversion are carried to the UT-400 router. You will also see an additional cable assembly that is used for the micro controller inside the router that communicates with the alarm circuitry inside router.

For mounting and connectivity considerations, the power supply is most appropriately located beneath the UT-400 router.



---

***In This Chapter***

This chapter contains descriptions of each video and audio board type contained within the Utah-400; including Input, Output, Crosspoint and Interface (midplane) cards, and Power Supplies. Information regarding LED indications and alarms is also provided.

- Video Input **4-3**
- Video Output Boards **4-5**
- Multirate Fiber Input Card - 121234-1 **4-7**
- Multirate Differential Pair Output Card – 121235-1 **4-9**
- Fiber Interface - (Optional) **4-11**
- Frame Controller **4-13**
- Monitor Matrix Module **4-15**
- Video Crosspoint Board **4-17**
- UT400 288x288 Crosspoint Card – 121248-1 **4-20**
- UT400 144x144 Crosspoint Card – 121242-1 **4-23**
- UT400 Series 2 Dis-Embedding SDI Fiber Input Card **4-26**
- UT400 Series 2 Dis-Embedding SDI Input Card – PN 121292-1 **4-30**
- UT400 Series 2 Embedding SDI Output Card – 121293-1/2 **4-34**
- UT400 Series 2 Embedding SDI Fiber Output Card – 121405-1 **4-39**
- UT400 Series 2 Triple Port MADI IO Card – 121320-1/2 **4-44**
- UT400 Series 2 12 Port TDM Crosspoint Submodule – 121295-1 **4-49**
- UT400 Series 2 528 Frame TDM Crosspoint Carrier – 121323-1 **4-51**
- UT4-528 Standard Digital Audio Input with TDM Board **4-53**
- UT4-528 Standard Digital Audio Output with TDM Board **4-59**
- UT4-528 Digital Audio Digital to Analog (DAC) Output with TDM Board **4-66**
- UT4-528 Digital Audio Analog to Digital (ADC) Input with TDM Board – 121325-1 **4-72**
- 72x72 AV Router Components **4-76**

UT400 72x72 Audio Crosspoint Card – 121338-1 **4-78**  
UT400 Series 2 Advanced Input Card – 121395-1 **4-82**  
UT400 Series 2 Advanced Output Card – 121396-1 **4-88**  
UT400 Series 2 MOHO Video + MADI Output Card **4-95**  
UT400 Series 2 MIHI Video + MADI Input Card **4-101**  
UT400 Series 2 SMPTE 2022 Receiver (121400-1) **4-106**  
UT400 Series 2 SMPTE 2022 Transmitter (121401-1) **4-116**  
Rear Panel Considerations **4-125**  
Power supplies **4-126**

---

## *Video Input*

Video connectivity on the back of the router is handled through BNC or Fiber (optional). The primary connection to the outside environment occurs via the MX bus. There are two MX bus connectors, with the second one terminated if no connection is to be made to another router.

### **Multi-rate**

Part # 121229-1, the Multi-rate SDI Input Card is designed to receive 12 individual single ended data streams at data rates between 3 Megabits per second to 3 Gigabits per second. This range allows the card to receive SMPTE SDI signals in the 259, 292 and 424 standards, as well as non SMPTE standards like DVB-ASI, AES-3 audio, and SMPTE-310 signals.

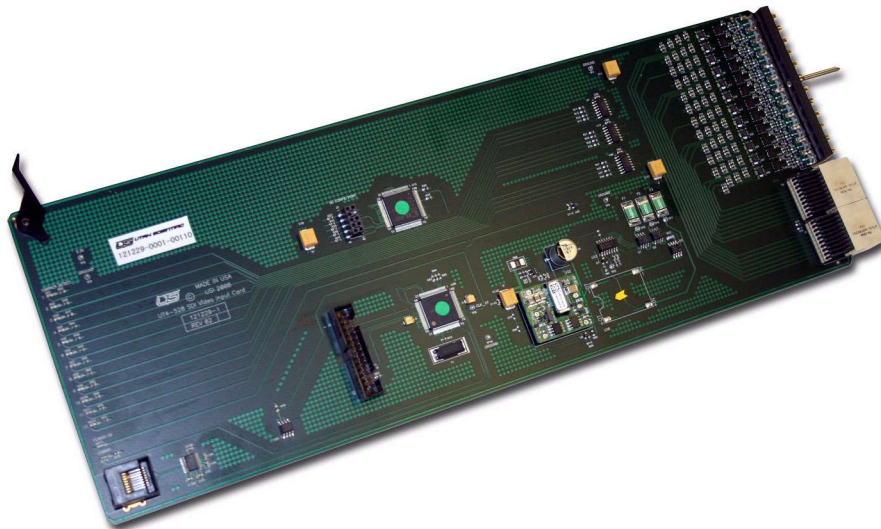

**FIGURE 4-1. Multi-rate Video Input Board**

---

### *Circuit Description*

The first stage of the card equalizes the signal to remove deterministic cable rolloff. It is capable of the following cable lengths for some standard SDI data rates –

- SMPTE-259C – 270 Mb/Sec – 350 Meter equalization capability
- SMPTE-292 – 1.485 Gb/Sec – 150 Meter equalization capability

- SMPTE-424 – 2.970 Gb/Sec- 100 Meter equalization capability

The equalization stage also provides an indication that the equalizer has detected and is equalizing a signal.

After the cable equalization stage, the signal enters a 1x4 fanout distribution stage. One of these four signals is driven to each individual crosspoint in the system. In this fashion, every crosspoint card has an identical copy of each input signal in the system.

### *Controls And Indicators*

There are no controls on this card, other than P1 which is a standard UT400 diagnostic port that provides detailed operational status and control for this card.

There are three types of indicators on this card –

1. Communications indicator – yellow. Illuminated when the card has been addressed by the Frame Controller Module.
2. PS Fail Led. – Red – Illuminated when the 3.3V power supply falls out of +- 5% tolerance.
3. Signal Present Detection LED's (12), Green. One of these LEDS is present on the front edge of the card for each input signal. They are labeled as 'Carrier Detect' 1-12. To use the Carrier detect numbering to help identify whether or not an input is present in the router, the CD1-12 must be translated to the particular router slot the card is inserted in. If the card is installed in the input 24-35 slot, for example, CD1 refers to input 24 of the system, and CD12 refers to input 35 of the system.

---

## Video Output Boards

The Utah-400's Video Output cards receive signals from the Crosspoint card, where user specified switching takes place. All three card types (below) perform a signal presence detection, while the SD and HD Output cards contain a re-clocking stage.

### Multi-rate

Part # 121230-1, the Multi-rate Output card is used to drive single ended data signals out of the router. It has integral Clock and Data Recovery circuits that operate on standard SMPTE Video frequencies and work to remove jitter from the signal. The cards also contain high quality, high capability cable driver components that allow them to drive long lengths of coax cable.

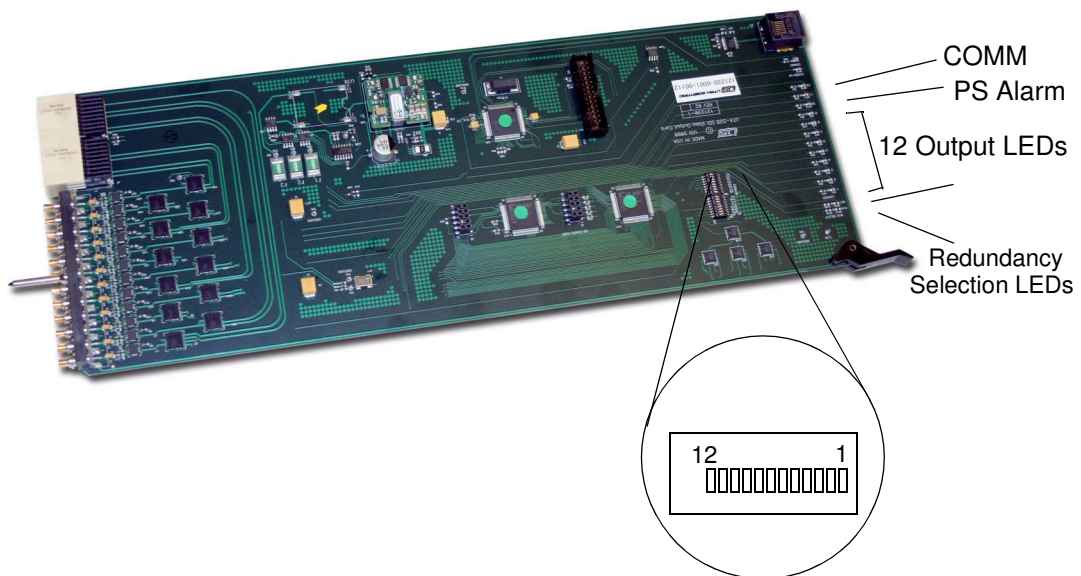

**FIGURE 4-2. Multi-rate Output Board**

---

### Circuit Description

Signals enter this card from multiple crosspoint cards. The control signals from the Frame Communication module determine whether the output stage selects signals from the Primary or Redundant Crosspoint cards.

Once an input is selected, the output stage typically reclocks it, unless the signal is not a standard SMPTE video frequency, and then the signal is bypassed.

After the signal passes thru the reclocker stage, it is presented to the cable driver stage which generates signal centered around 0V with an amplitude of 800mV. The rise and fall time of these signals will adhere to the SMPTE specification for the signal type, or default to a 200pSec risetime if the signal type is non-standard.

### *Controls and Indicators*

This card has a two bank dipswitch with 16 total switches. 12 of them are used to force a bypass condition on each of the 12 individual outputs (Labeled as P1-P12). To force a bypass condition on an individual port, move the dipswitch towards the word 'BYPASS'

On the PCB. TO allow it to automatically select the proper mode, move it away from the bypass indication on the PCB. The other four dipswitch locations should remain placed toward their labeling on the PCB. P1 is a standard UT400 diagnostic port that provides detailed operational status and control for this card.

There are Four types of indicators on this card –

1. Communications indicator – yellow. Illuminated when the card has been addressed by the Frame Controller Module.
2. PS Fail Led. – Red – Illuminated when the 3.3V power supply falls out of +- 5% tolerance.
3. Reclocker Locked LED's (12), Green. One of these LEDS is present on the front edge of the card for each input signal. They are labeled as 'Locked' 1-12. To use the Carrier detect numbering to help identify whether or not an input is present in the router, the CD1-12 must be translated to the particular router slot the card is inserted in. If the card is installed in the input 24-35 slot, for example, CD1 refers to input 24 of the system, and CD12 refers to input 35 of the system. It is important to note that if the reclocker is bypassed, either manually or automatically, signal could still be passing thru the output if the LED is OFF.
4. Redundancy selection LED's. These are two LEDS nearest the edge connector of the card that indicate which crosspoint the card is getting signal from. DS15 is labeled P/R and indicates that the card is receiving signals from its redundant crosspoint when it is illuminated. DS16, labeled as N/I, indicates that output 0 of the card is receiving signals from its Mezzanine Level redundancy crosspoint card.



---

## Multirate Fiber Input Card - 121234-1

### General

This card is designed to receive 12 individual differential pair data streams at data rates between 3 megabits per second to 3 gigabits per second. This range allows the card to receive SMPTE SDI signals in the 259, 292, and 424 standards as well as non SMPTE standards like DVB-ASI, AES-3 audio, and SMPTE-310 signals.

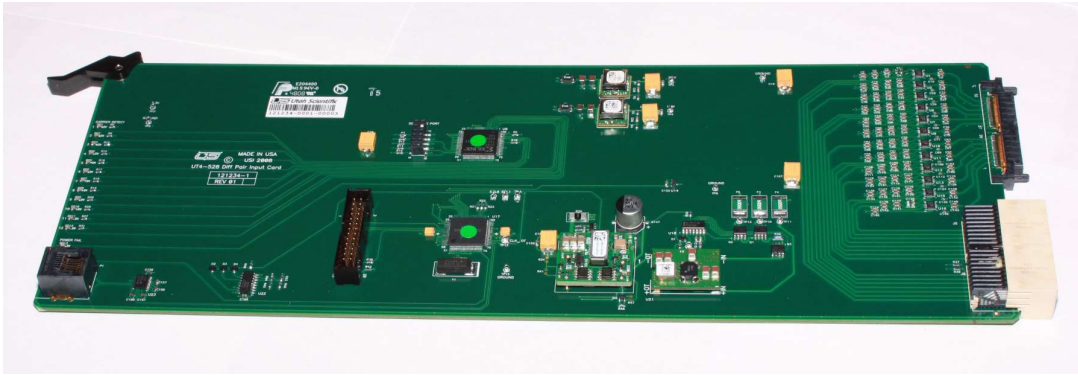

FIGURE 4-3. 121234-1

This card is to be plugged into a rear panel slot that is occupied with either an 121232-2 fiber optic input rear panel or a 121246-1 Differential Pair IO rear panel. The 121232-2-1 Fiber Optic rear panel can be fitted with fiber optic transceivers and used to receive signals over single mode fiber. The 121246-1 differential pair input rear panel is used when the router system is fed with DA's from the UT100/3 series.

### Circuit Description

After the 12 differential pairs enter this card from edge connector J1, the signal enters a 1x4 fanout distribution stage. One of these four signals is driven to each individual crosspoint in the system. In this fashion, every crosspoint card has an identical copy of each input signal in the system.

### Controls and Indicators

There are no controls on this card, other than P1 which is a standard UT400 diagnostic port that provides detailed operational status and control for this card.

There are three types of indicators on this card –

1. Communications indicator – yellow. Illuminated when the card has been addressed by the Frame Controller Module.
2. PS Fail LED. – Red – Illuminated when the 3.3V power supply falls out of + - 5% tolerance.
3. Signal Present Detection LED's (12), Green. One of these LEDs is present on the front edge of the card for each input signal. They are labeled as 'Carrier Detect' 1-12. these LED's are only illuminated if a Fiber IO rear panel is fitted, and the Fiber SFP modules report that they are receiving an optical carrier. If no carrier is present, or in the case of a Differential pair input signal from a DA, these LEDs will never be lit.

---

## *Multirate Differential Pair Output Card – 121235-1*

---

### *General*

This card is used to drive differential pair signals out of the router to either Multi-Viewer systems or Fiber Optic SFPs on the rear panel of the router. It has integral Clock and Data Recovery circuits that operate on standard SMPTE Video frequencies and work to remove jitter from the signal.

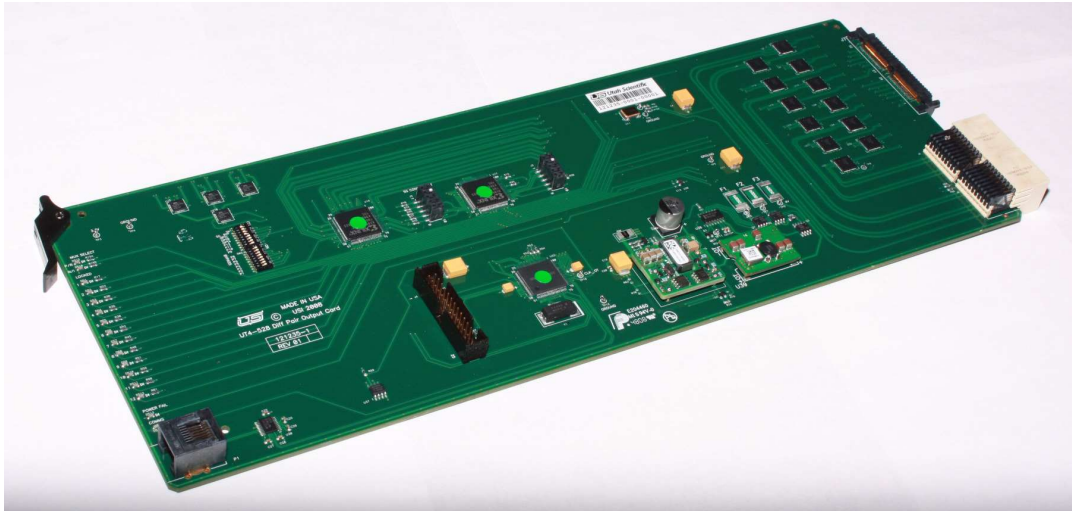

**FIGURE 4-4. 121235-1**

---

### *Circuit Description*

Signals enter this card from multiple crosspoint cards. The control signals from the Frame Communications module determine whether the output stage selects signals from the Primary or Redundant Crosspoint cards.

Once an input is selected, the output stage typically reclocks it, unless the signal is not a standard SMPTE video frequency, and the signal is bypassed.

After the signal passes thru the reclocker stage, it is presented to the rear panel where it may be connected to either an 121232-1 Fiber Optic Output Rear panel or an 121246-1 Differential Pair rear panel.

### *Controls and Indicators*

This card has a two bank dipswitch with 16 total switches. 12 of them are used to force a bypass condition on each of the 12 individual outputs (Labeled as P1-P12). To force a bypass condition on an individual port, move the dipswitch towards the word 'BYPASS' on the PCB. To allow it to automatically select the proper mode, move it away from the bypass indication on the PCB. The other four dipswitch locations should remain placed toward their labeling on the PCB. P1 is a standard Ut400 diagnostic port that provides detailed operational status and control for this card.

There are four types of indicators on this card –

1. Communications indicator – yellow, Illuminated when the card has been addressed by the Frame Controller Module.
2. PS fail LED – Red – Illuminated when the 3.3V power supply falls out of + - 5% tolerance.
3. Reclocker Locked LEDs (12), Green. One of these LEDs is present on the front edge of the card for each input signal. They are labeled as 'Locked' 1 – 12. To use the 'Locked' numbering to help identify whether or not an input is present in the router, the Locked 1-12 must be translated to the particular router slot the card is inserted in. If the card is installed in the input 24-35 slot, for example, Locked 1 refers to input 24 of the system, and Locked 12 refers to input 35 of the system. It is important to note that if the reclocker is bypassed, either manually or automatically, signal could still be passing through the output if the LED is off.
4. Redundancy selection LEDs. These are two LEDs nearest the edge connector of the card that indicate which crosspoint the card is getting the signal from. DS15 is labeled P/R and indicates that the card is receiving signals from its redundant crosspoint when it is illuminated. DS16, labeled as N/I, indicates that output 0 of the card is receiving signals from its Mezzanine Level redundancy crosspoint card.

---

### *Fiber Interface - (Optional)*

The MADi system contains the option of using BNC or fiber for the MADi signals. Instead of using BNCs for the physical connection, the system can utilize small modules that plug directly into the rear of the UT-400 chassis.

The small modules are responsible for the electrical-optical conversion, and are removable if service is required.



**FIGURE 4-5. SP2T - Transmitter module**

---

The SP2R is the receiver module, and is a part of the MADi Input card assembly. The SP2T is the transmitter module, and is part of the MADi output card assembly. These modules are removed and replaced by moving the swinging bale (at the end) out of, and back in to the locked position.

**Note: Board dip switches will designate BNC or Fiber setup.**

### Specification Detail

- Optical Fiber Output – 1310 nm class 1 laser.
- Optical Output Power - -12dB minimum
- Optical Fiber Type – 9/125 uM Single Mode Fiber
- Connector Type - LC
- Typical Cable Length – 18 Miles SD, 10 Miles HD
- Optical Fiber Input – 1310 nm Class1 laser
- Optical Input Power - -20dB min
- Optical Fiber Type – 9/125 uM Single Mode Fiber
- Connector Type - LC

Typical Cable Length – 18 Miles SD, 10 Miles HD

---

## *Frame Controller*

### **Overview**

Part # 121228-1, the Frame Controller Module has the system function of coordinating all switching and reporting functions from the control system and applying them to the router hardware. It has several communications busses, including the Utah Scientific MX-Bus which carries crosspoint switches and general status to and from the control system, a diagnostic serial port, and an Ethernet port for more detailed status and control.

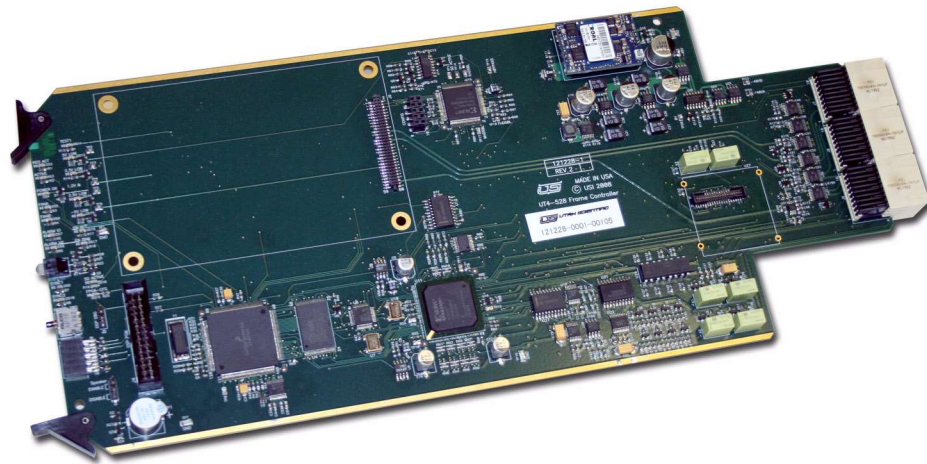

**FIGURE 4-6. Frame Controller card**

---

### *Circuit Description*

The heart of the FCM is a DSP / FPGA combination that allows the FCM to process the large amount of switches required for this system.

Dedicated high speed control and status busses to each crosspoint and 12 busses that communicate to the total 88 IO cards make up the interconnect between the FCM and the other boards in the system. The FCM operates as a redundant pair with an identical card in the adjacent slot.

In UT400-528 systems that include discrete AES IO cards, the FCM has a submodule that generates AES frame sync and word clocks for distribution to the AES Input Cards

### *Controls and Indicators*

Controls for this card are concentrated on the router rear panel, in the Ethernet and Diagnostic serial ports. The only board level control is the Speaker Enable or Disable jumper, J3, that allows the audible alarm to be turned off. The audible alarm sounds any time that the SMPTE alarm is on.

The following LED's indicate different board conditions:

- DS1 – SMPTE Alarm – RED/GREEN – Red when any error condition exists, green otherwise.
- DS2 – Redundant Active – Green – When illuminated indicates that this card is the redundant card in the pair and is actively monitoring the primary card.
- DS3 – Active – Green – When illuminated indicates that this is the Active card in the pair and is currently managing the system.
- DS4 – Power OK – Green – Illuminated when all on board power supplies are OK.
- DS5 – DS6 – FANA, FANB - Green – Indicates the health of the fan modules in the system.

***NOTE – In 288 router chassis, there is only a single fan module. Because of this, the red FANB LED will always be lit. The system knows this is not an error in 288 systems so DS1 will remain green, indicating that no error condition exists.***

- DS7 – ALARM IO – RED – Indicates that an alarm condition exists on one or more of the IO modules when illuminated.
- DS8 – ALARM XP - Indicates that an alarm condition exists on one or more of the XP modules when illuminated.
- DS9, DS10 - SYNC – GREEN – Indicates presence of reference for the Sync1 and Sync2 ports.
- DS12 – 5V LOW - RED - Indicates an alarm condition for the on board 5V power supply.
- DS13 – 3.3V LOW - RED - Indicates an alarm condition for the on board 3.3V power supply.
- DS14 – 1.2V & 2.5V LOW - RED - Indicates an alarm condition for the on board 1.2V and 2.5V power supply.
- DS15 – -5V LOW - RED - Indicates an alarm condition for the on board -5V power supply.



---

## Monitor Matrix Module

### Overview

Part # 121227-1, the Monitor Matrix module is a standard system component that allows for all input and output signals of the router to be presented to a single port. It allows for two copper and one streaming<sup>1</sup> Ethernet signal from the router core to be monitored at the users discretion.

No other system operation is dependant on the Monitor Matrix module.

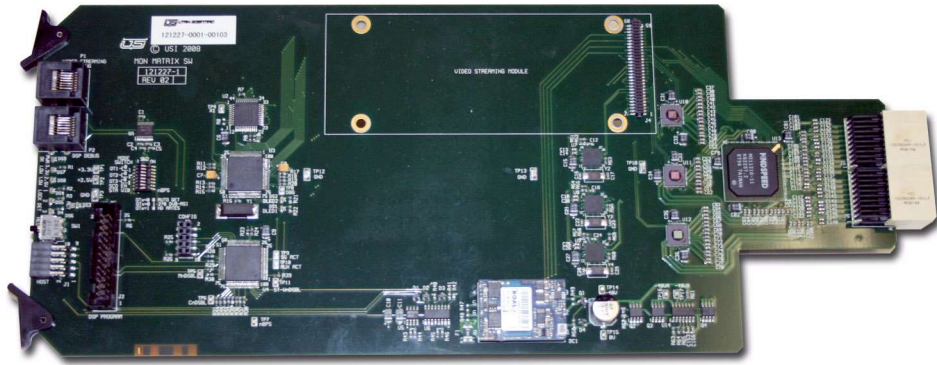

FIGURE 4-7. Monitor Matrix card

---

### Circuit Description

The monitor matrix resides on the same control bus from the FCM that other system components do. This allows Monitor Matrix commands sent to the FCM by the MX Bus based control system to be communicated to the Monitor Matrix card.

The card consists of a 46x3 crosspoint array that is fully capable of SMPTE-424 and lower data rates. This crosspoint array allows for one signal from each output card, one signal from the crosspoint card for input signals, and one signal from a partner matrix to allow for expansion. Each of the three outputs can be selected independently, with the limitation that each output card can only provide a single signal at a time to the Monitor Matrix.

---

1. The streaming output is optional.

Once the signal has been selected, the crosspoint passes that signal to a reclocker where the signal is re-timed. It is then presented to a Cable driver and BNC in the case of the two electrical signals, or to the baseband to streaming (optional) submodule board. This board is discussed separately.

### **Controls and Indicators**

SW1 is a board reset switch, which will restart all card functions when pressed.

SW2 allows some manual control over the behavior of the output reclocking parts for the MMX outputs. Normally, all switches in the SW2 switch bank should be set in the off position.

P1 is a standard UT400 diagnostic port that provides detailed operational status and control for this card.

### **Indicators.**

The following LED's reflect system status:

- DS9 – Green – Indicates power supplies are healthy when illuminated.
- DS7 and DS8 – Red – Indicate that either the 2.5V or 3.3V circuits have voltage problems. DS9 will be out if either of these LED's is on.
- DS4, DS5 and DS6 – Green – When illuminated, provide an indication that output 1, 2 and 3 respectively is active and is being reclocked.
- DS1, DS2 – Green – These LED's indicate communication with the system FCM when they are flashing.

---

## *Video Crosspoint Board*

### **Overview**

Part # 121222-1, the Video Crosspoint Card is the central component in the UT400 528 routing switcher. The same card can be placed in any one of the four crosspoint card slots in the system without changing any configuration settings on the card.

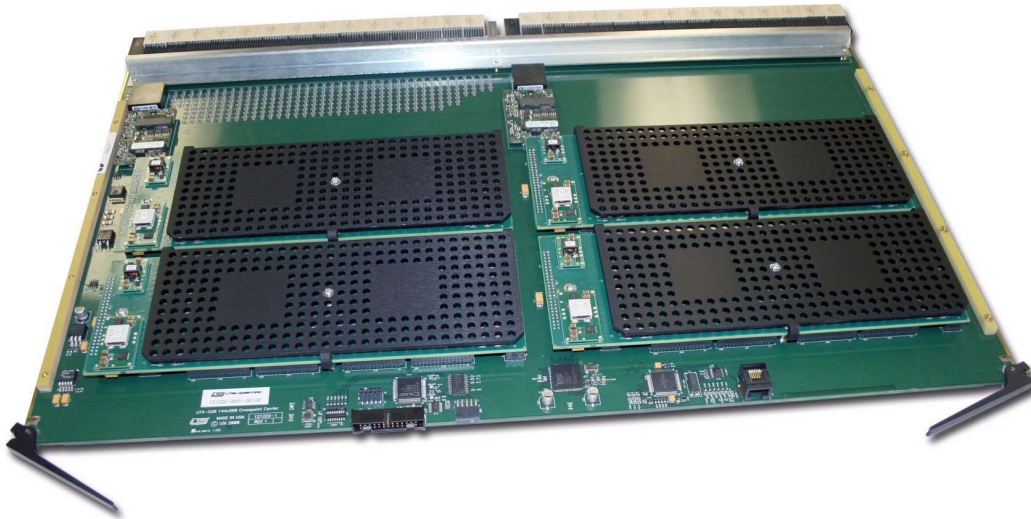

**FIGURE 4-8. Video Crosspoint Card**

---

The card uses four discrete 144 in x 288 out crosspoint sub-modules installed on a carrier card to comprise a 576 in x 288 out fully differential crosspoint array that is capable of signal from DC to 3.2Gb/Sec.

The card also contains voltage regulation circuitry that converts the two possible 48 volt inputs to 3.3V, which is used by the carrier and further regulated to 1.2V and 1.8V on the crosspoint sub modules. Switching is controlled via two discrete control busses from the Frame Control Module.

### **Circuit Description**

Each of the 576 input signals differential input signals is carried to a single crosspoint module, where it is resistively split and applied to two different 144x144 crosspoint chips.

The outputs of the four crosspoint modules are passively combined, and coupled with the proper switching commands from the Frame Controller Module, allow for the large crosspoint array size.

The control circuitry that decodes the control bus's from the Frame Control Modules is made up of an FPGA and a DSP co-processor that monitors critical crosspoint functions as well as implementing the switch commands sent to the card by the FCM.

### **Controls and Indicators**

Controls on this card are limited to a reset switch (SW2), which resets and restarts all processing activity on the card, and the factory set dipswitch SW1, which will not require any user adjustments. P1 is a standard UT400 diagnostic port that provides detailed operational status and control for this card.

There are several LED's on this card that indicate operational status. Their behavior is defined below:

- DS1 – FPGA Load – Green - Illuminated when the FPGA is configured. If it is off, the card is not functional.
- DS2 – PSA FAIL – RED - Illuminated when the 'A' 48V to 3.3V converter is non-functional.
- DS3 – PSBA FAIL – RED - Illuminated when the 'B' 48V to 3.3V converter is non-functional.
- DS4 – Health – RED – Illuminated when the internal monitoring circuit detects ANY non-ideal conditions on the card.
- DS5 – FCM COM – Yellow – Illuminated when this card is selected by the Frame Communication Module
- DS6 – Undefined
- DS7 – Undefined
- DS8 – XP-PSOK – Green – Illuminated when all 8 PS sub module power supplies are OK.
- DS9 – SEAT – Green – Illuminated when all rear panel sampling points are satisfied, indicating that the crosspoint card is seated properly.
- DS10 – SG Activity – Indicates that the local Scangate part is active.

---

**Video Crosspoint Board**

---

*Crosspoint LEDs (Active)*

The yellow LED pulses continuously when conditions are normal. A solid LED indicates the 'standby' crosspoint in a redundant system.

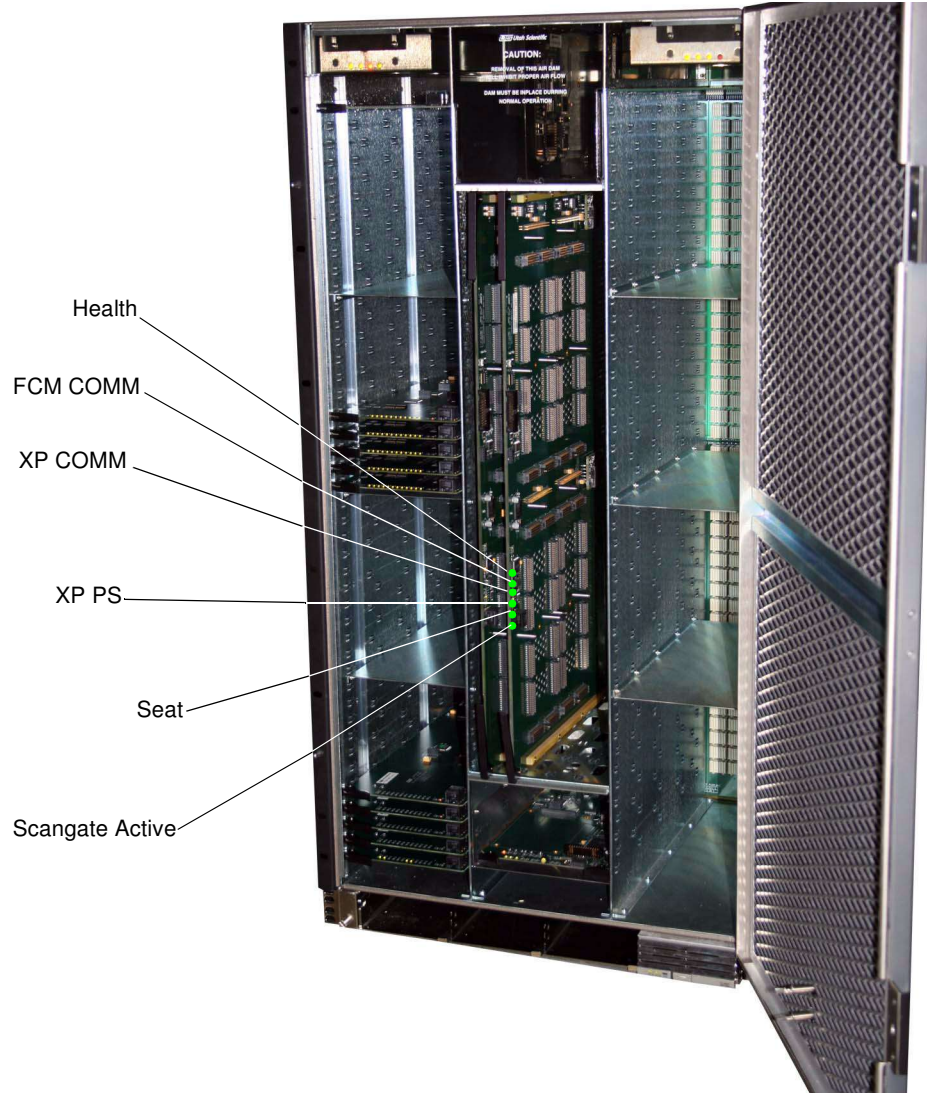

**FIGURE 4-9. Video Crosspoint LEDs**

---

---

## *UT400 288x288 Crosspoint Card – 121248-1*

### General

The 121248-1 288 Crosspoint Card is the central component in the 12 RU 288x288 UTAH400 router. It contains circuitry to control a 288x288 switching array based on commands from the MX-BUS, power supply circuitry and alarm reporting circuitry. It also has locations for two optional plug on modules, a TDM Audio Crosspoint and a H.264 streaming<sup>2</sup> Monitor Matrix card.

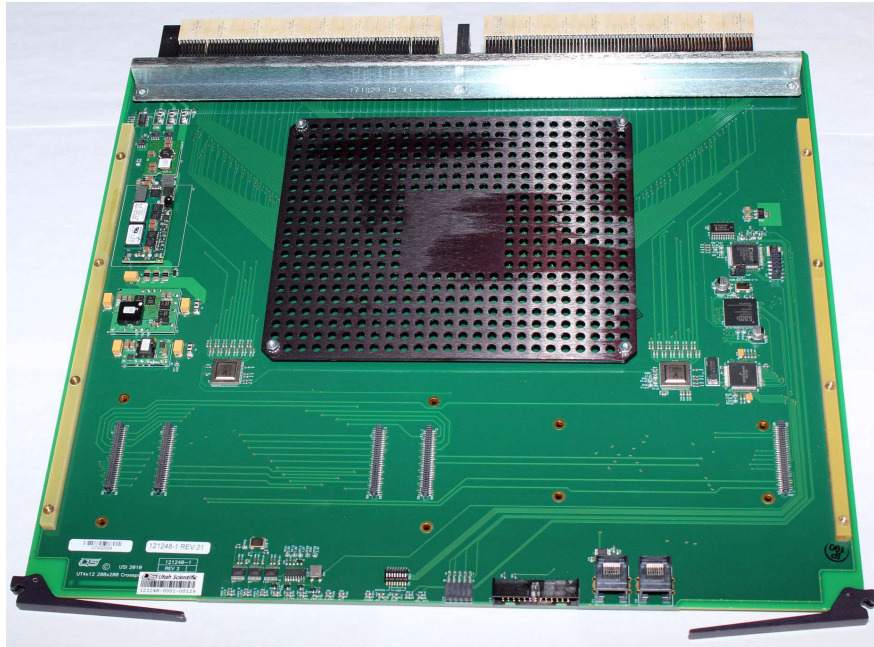

**FIGURE 4-10. Crosspoint Card - part # 121248-1**

---

### Circuit Description

The upper end of the card is the power supply section. U1 is a redundant power supply switch that determines which of the two -48V power supply inputs is most healthy, and directs that

---

2. The streaming output is optional.

supply to its output for the rest of the board to use. From there, the supply is filtered by U4 and presented to U1, which converts it to 3.3VDC at 50 amps.

This 3.3V supply is further regulated down by U24, U5 and U3 to 2.5V at 1.5A, 1.8V at 10A and 1.2V at 40A. U12, at the board front edge, measures and determines the health of each of these lower supplies, and will generate alarms if any are faulty. DS7, a green LED on the board front edge, lights when all supplies are good.

The lower end of the card contains all of the control circuitry on the board. This consists mainly of U17, an 16 bit DSP, and U18, an FPGA. U18 receives commands from the external MX-BUS and switches the crosspoint chip appropriately, while U17 monitors the health of the board and reports that back to the system level Frame Controller Module for reporting to the external world.

The video switching core of the system is in the center of the board, U13, which is a 3.2Gb/Sec 288x288 crosspoint chip in a 2398 ball BGA package. It is covered by a large heat sink. It receives the 1.2V and 1.8V rails from the power supply section, a 30 bit control bus from U18, and 288 inputs from video input cards and drive 288 video outputs to output cards.

The monitor matrix is made up of U7 and U15, which are both 12x12 3.2Gb/Sec crosspoint chips. These receive signals from the 24 output cards in the system and generate 3 different output signals, two for the copper MMX outputs and one that goes to the streaming (optional) monitor matrix module.

## **Controls and Indicators**

### *Controls*

SW1 – Momentary push button reset switch. Resets all processing on the card.

SW2 – 8 Position Dipswitch. Used for board programming and custom settings.

J15 - Header for connection of a JTAG pod for programming the FPGA.

J17 – Header for programming the DSP, from a PC parallel port.

P1 – Used for serial diagnostics of the card from a RS-232 port.

P2 – Serial diagnostic header for the streaming (optional) MMX module.

### *Indicators*

DS1 – Reclocker locked indication for MMX out 1 - GREEN.

DS2 – Reclocker locked indication for MMX out 2 - GREEN.

- DS3 – Reclocker locked indication for streaming (optional) MMX output - GREEN.
- DS4 – 1.2 or 1.8V failure indication – RED.
- DS5 – 2.5V failure indication – RED.
- DS6 – 3.3V failure indication – RED.
- DS7 – Power Supply OK indication – GREEN.
- DS8 – Health Indication – RED – On if there is a problem.
- DS9 – Comms from FCM indicator – Yellow.
- DS11 - Comms to crosspoint chip – GREEN – On if OK.
- DS12 – Power Supply OK LED – GREEN.
- DS13 – Seating LED – Indicates that the crosspoint card is correctly installed in its slot when green.
- DS14 – FPGA programming complete – GREEN.
- DS15 – Scangate active LED – Yellow.



---

*UT400 144x144 Crosspoint Card – 121242-1*

---

**General**

The 121242-1 144 Crosspoint Card is the central component in the 7 RU 144x144 UTAH400 router. It contains circuitry to control a 144x144 switching array based on commands from the MX-BUS, power supply circuitry and alarm reporting circuitry. It also has locations for two optional plug on modules, a TDM Audio Crosspoint and a H.264 streaming<sup>3</sup> Monitor Matrix card.

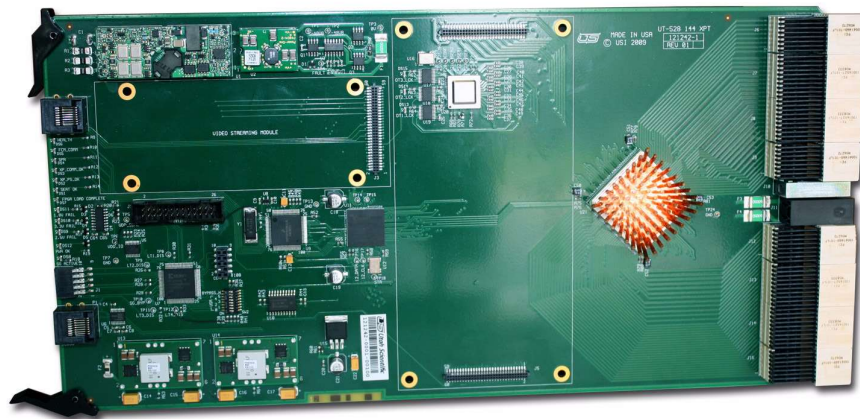

FIGURE 4-11.

---

**Circuit Description**

The upper front of the card is the power supply section. U3 is a redundant power supply switch that determines which of the two -48V power supply inputs is most healthy, and directs that supply to its output for the rest of the board to use. From there, the supply is filtered by U2 and presented to U1, which converts it to 3.3VDC at 50 amps. This 3.3V supply is further regulated down by U15, U14 and U13 to 2.5V at 3A, 1.8V at 10A and 1.2V at 10A. U4, at the board front edge, measures and determines the health of each of these lower supplies, and will generate alarms if any are faulty. DS11, a green LED on the board front edge, lights when all supplies are good.

---

3. The streaming output is optional.

The center front of the card contains all of the control circuitry on the board. This consists mainly of U9, an 16 bit DSP, and U11, an FPGA. U11 receives commands from the external MX-BUS and switches the crosspoint chip appropriately, while U9 monitors the health of the board and reports that back to the system level Frame Controller Module for reporting to the external world.

The video switching core of the system is in the center of the board, U21, which is a 4.25Gb/Sec 144x144 crosspoint chip in a 1156 ball BGA package. It is covered by a large heat sink. It receives the 1.2V and 1.8V rails from the power supply section, a 30 bit control bus from U11, and 144 inputs from video input cards and drives 144 video outputs to output cards.

The monitor matrix is made up of U20, which is a 12x12 3.2Gb/Sec crosspoint chip. It receives signals from the 12 output cards in the system and generates 3 different output signals, two for the copper MMX outputs and one that goes to the streaming (optional) monitor matrix module.

## **Controls and Indicators**

### *Controls*

SW3 – Momentary push button reset switch. Resets all processing on the card.

SW2 – 8 Position Dipswitch. Used for board programming and custom settings.

J15 - Header for connection of a JTAG pod for programming the FPGA.

J1 – Header for programming the DSP, from a PC parallel port.

P1 – Used for serial diagnostics of the card from a RS-232 port.

P2 – Serial diagnostic header for the streaming (optional) MMX module.

### *Indicators*

DS15 – Reclocker locked indication for MMX out 1 - GREEN.

DS14 – Reclocker locked indication for MMX out 2 - GREEN.

DS13 – Reclocker locked indication for streaming (optional) MMX output - GREEN.

DS9 – 1.2 or 1.8V failure indication – RED.

DS10 – 2.5V failure indication – RED.

DS8 – 3.3V failure indication – RED.

DS11 – Power Supply OK indication – GREEN.

DS1 – Health Indication – RED – On if there is a problem.

DS2 – Comms from FCM indicator – Yellow.

DS4 - Comms to crosspoint chip – GREEN – On if OK.

DS5 – Power Supply OK LED – GREEN.

DS6 – Seating LED – Indicates that the crosspoint card is correctly installed in its slot when green.

DS7 – FPGA programming complete – GREEN.

DS12 – Scangate active LED – Yellow.

## *UT400 Series 2 Dis-Embedding SDI Fiber Input Card – PN 121406-1*

### **General**

This module serves as a standard multi rate SDI input card, with the added features of 12 separate audio dis-embedder modules and a TDM multiplexor that feeds all of the dis-embedded audio to a central crosspoint.



**FIGURE 4-12.**

The video circuitry supports SDI video signals from 270 Mb/Sec to 2.97 Gb/Sec, SMPTE 259, 292 and 424 standards.

The dis-embedder circuitry supports 16 channels of audio, or 4 audio groups, for SMPTE 292 and 424 standards, and 8 channels of audio, or 2 audio groups, for SMPTE 259 standards. Each dis-embedder channel is fully isolated from the others, so different video standards can be presented to a single card in any combination required. Each channel derives its necessary clocks from the incoming video stream.

The overriding concern with a TDM audio system such as the Utah 400 ESP system is that the audio **MUST** be 48 KHz sample rate, and it **MUST** be synchronous with the AES reference presented to the router. Asynchronous audio signals will not pass thru the system correctly.

## **Circuit Description**

### *Video Path*

The video signals presented to this card come from an SFP module on the rear panel. This could be an optical to electrical SFP of one of the FLEX-IO modules that are available. It is equalized by a 1x2 fanout component.

After equalization, the signal splits. One copy feeds a 1-4 fanout DA that sends the equalized signals to the router crosspoint cards. The other feeds the dis-embedder circuitry.

### *Audio path*

The output of the dis-embedder components are 8 AES pairs per channel. These feed an onboard audio processor component that receives the 96 AES pairs and the system wide audio clock and sync signals derived from the system audio reference. This audio processor generates a multiplexed signal carrying 192 unique audio channels, running at approximately 700 Mb/Sec.

This signal is then presented to a 1-4 fanout DA that sends the audio signals to the router crosspoint cards.

### *Control*

The 121406-1 card has an onboard microprocessor that manages housekeeping tasks such as measuring current draw and temperature, and acts as the control path for the system Frame Controller module to gather status and make changes to the card.

## **Power Supplies**

The 121406-1 card receives -48V from the system backplane and generates 3.3V, 2.5V, 1.8V, 1.2 V and three separate 1.2V voltages for the SDI receivers in the dis-embedder components. All voltages are monitored for health and the failure of one of them will result in a dark 'Power Good' LED (DS14).

## **Controls And Indicators**

### *Controls*

SW1 Dipswitch – Used for card programming, no user adjustments.

SW2 Reset switch - Pressing this switch performs a cold reset of the board.

### *Indicators*

DS11 – Green - ON indicates that the audio processor circuit is configured.

DS17 – Green – ON indicates that the dis-embedder circuit is configured.

DS1-10, 12, 13 – Green – Input Locked - Video Inputs 1-12 respectively. ON indicates that the dis-embedder circuit has locked to the incoming video.

DS14 – Green –POWER GOOD - ON indicates that all supplies are healthy.

DS15- Red – Alarm - ON Indicates that there is a fault with the board. Further diagnostics can be done via the serial port or system monitoring applications.

DS16 – Yellow – Comms - ON indicates that the card is being addressed by the router control system.

### **Specifications**

#### Power Consumption

- 30 Watts (.62A of -48V), with 6 Digital Dual Rx Digital Optical Receiver Modules installed in the rear panel.
- Supported Video Formats
- SMPTE259C – 525 Line and 625 Line
- SMPTE292 – 1080i 50/60 Hz, 720P 50/60 Hz
- SMPTE424 - 1080P 59.94/50/60 Hz Level A only

## Rear Panel Connections

The card uses the standard Fiber IO panel for series 2 routers. (121232-1)

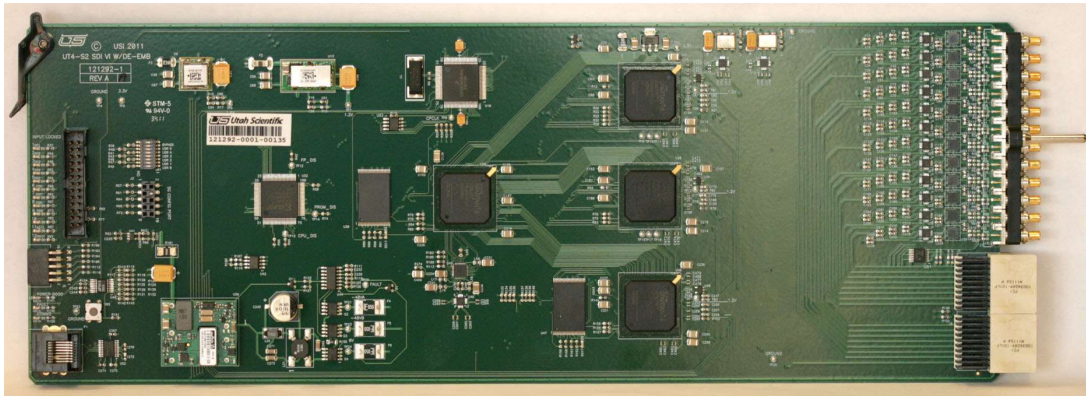

FIGURE 4-13.

## *UT400 Series 2 Dis-Embedding SDI Input Card – PN 121292-1*

### **General**

This module serves as a standard multi rate SDI input card, with the added features of 12 separate audio dis-embedder modules and a TDM multiplexor that feeds all of the dis-embedded audio to a central crosspoint.



**FIGURE 4-14.**

The video circuitry supports SDI video signals from 270 Mb/Sec to 2.97 Gb/Sec, SMPTE 259,292 and 424 standards.

The dis-embedder circuitry supports 16 channels of audio, or 4 audio groups, for SMPTE 292 and 424 standards, and 8 channels of audio, or 2 audio groups, for SMPTE 259 standards. Each dis-embedder channel is fully isolated from the others, so different video standards can be presented to a single card in any combination required. Each channel derives its necessary clocks from the incoming video stream.

The overriding concern with a TDM audio system such as the Utah 400 ESP system is that the audio **MUST** be 48 KHz sample rate, and it **MUST** be synchronous with the AES reference presented to the router. Asynchronous audio signals will not pass thru the system correctly.



## **Circuit Description**

### *Video Path*

The video signals presented to this card pass thru a cable equalization component prior to being used. This component is designed specifically to recover SMPTE SDI video signals after long runs of coaxial cable, and is rated in the amount of 1694A cable that it can equalize. The ratings are - 200 meters for 2.97 Gb/Sec signals, 220 Meters of 1.485 Gb/Sec signals, and 400 meters for 270 Mb/Sec signals.

After equalization, the signal splits. One copy feeds a 1-4 fanout DA that sends the equalized signals to the router crosspoint cards. The other feeds the dis-embedder circuitry.

### *Audio path*

The output of the dis-embedder components are 8 AES pairs per channel. These feed an onboard audio processor component that receives the 96 AES pairs and the system wide audio clock and sync signals derived from the system audio reference. This audio processor generates a multiplexed signal carrying 192 unique audio channels, running at approximately 700 Mb/Sec.

This signal is then presented to a 1-4 fanout DA that sends the audio signals to the router crosspoint cards.

### *Control*

The 121292-1 card has an onboard microprocessor that manages housekeeping tasks such as measuring current draw and temperature, and acts as the control path for the system Frame Controller module to gather status and make changes to the card.

## **Power Supplies**

The 121292-1 card receives -48V from the system backplane and generates 3.3V, 2.5V, 1.8V, 1.2 V and three separate 1.2V voltages for the SDI receivers in the dis-embedder components. All voltages are monitored for health and the failure of one of them will result in a dark 'Power Good' LED (DS14).

## Controls And Indicators

### *Controls*

SW1 Dipswitch – Used for card programming, no user adjustments.

SW2 Reset switch - Pressing this switch performs a cold reset of the board.

### *Indicators*

DS11 – Green - ON indicates that the audio processor circuit is configured.

DS17 – Green – ON indicates that the dis-embedder circuit is configured.

DS1-10, 12, 13 – Green – Input Locked - Video Inputs 1-12 respectively. ON indicates that the dis-embedder circuit has locked to the incoming video.

DS14 – Green –POWER GOOD - ON indicates that all supplies are healthy.

DS15- Red – Alarm - ON Indicates that there is a fault with the board. Further diagnostics can be done via the serial port or system monitoring applications.

DS16 – Yellow – Comms - ON indicates that the card is being addressed by the router control system.

## Specifications

### *Power Consumption*

14 Watts (.29A of -48V)

### *Input Return Loss*

Less than -15 dB to 1.5 Ghz, Less than -10 dB to 3 Ghz.

Cable Equalization Capability (Belden 1694A cable)

200 meters for 2.97 Gb/Sec signals

220 Meters of 1.485 Gb/Sec signals

400 meters for 270 Mb/Sec signals.

### *Supported Video Formats*

SMPTE259C – 525 Line and 625 Line

SMPTE292 – 1080i 50/60 Hz, 720P 50/60 Hz

SMPTE424 - 1080P 60/50/59.94 Level A only

### **Rear Panel Connections**

All connections are via BNC connector. The card uses the standard BNC IO panel for series 2 routers. (121226-1)

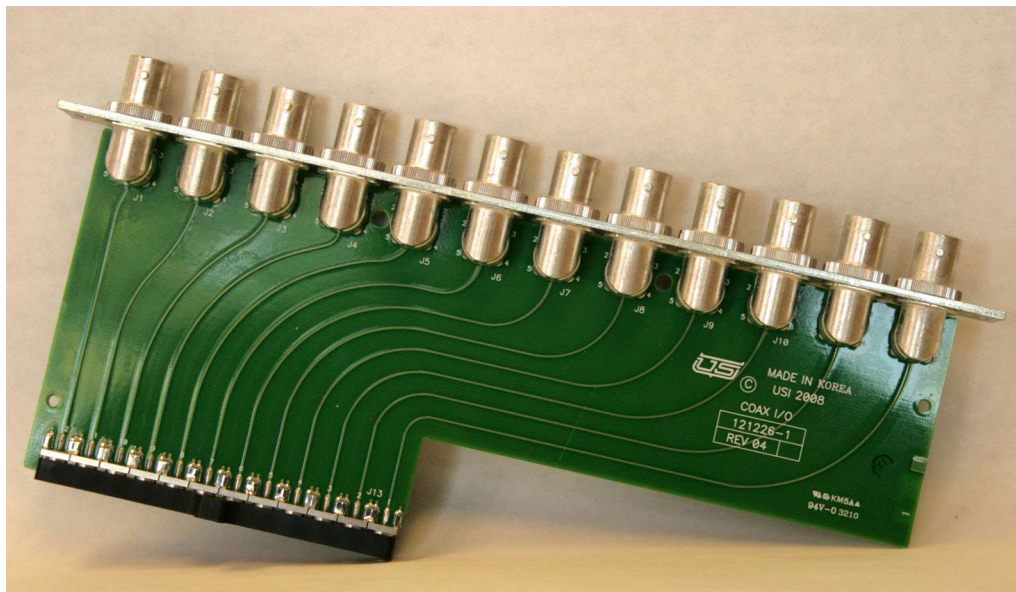

**FIGURE 4-15.**

---

## *UT400 Series 2 Embedding SDI Output Card – 121293-1/2*

### General

This card serves the same purpose as the standard SDI Output card with the added features of being able to either;

1. Selectively replace the embedded audio with audio signals delivered to this card from a TDM crosspoint, or
2. Shuffle the embedded audio within one video channel to the users requirements.

The distinction between these two functions is based on a different type of firmware loaded in the boards, and a different sub part number. The 121293-1 is the embedder card, and the 121293-2 is the shuffler card.

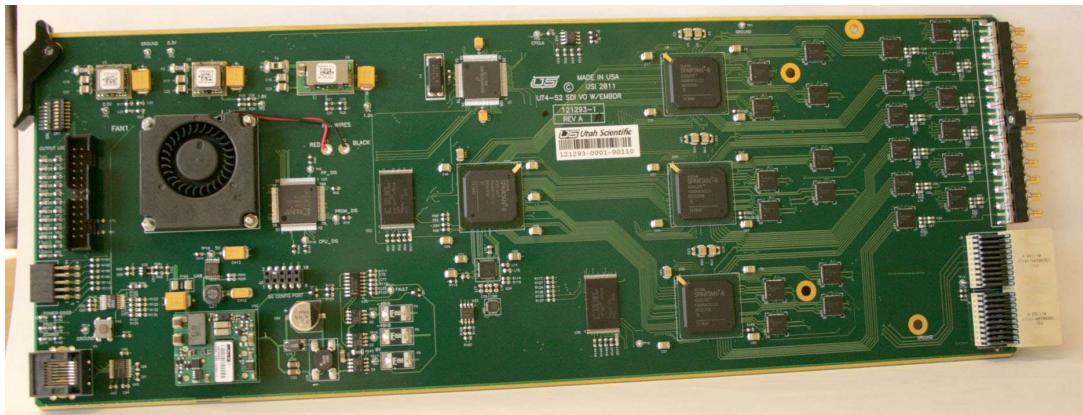

**FIGURE 4-16.**

Each card has 12 fully independent video channels that allow for different video standards on adjacent channels. Audio timing information, which is only required for the Embedder version of the card, is derived from the TDM stream delivered to the board.

The video path on the card includes a de-serializer – serializer pair that is always enabled in part of the signal path. Regardless of the state of the embedders or shuffler, the delay associated with this serialization / de-serialization is approximately 4 micro seconds. The video data is relocked within this process, ensuring an output with the lowest possible jitter. The serializer component also includes a SMPTE compliant cable driver.

All portions of the video path are capable of passing SMPTE 259 and 292 (SMPTE 424 3G is NOT supported). Because this path is specific to SMPTE SDI signals, no other signal types can be passed through this card.

## **Circuit Description**

### *Video Path*

The video signals presented to this card originate at the video crosspoint card in the system. Each video channel has two possible paths, from either the primary or the redundant crosspoint card. The signals arrive as a differential pair from the crosspoint.

The first component they connect to is a reclocking de-serializer component. The output of this part goes to an FPGA component which shuffles or inserts audio channels into the video stream.

From here, the signal is fed into a serializer/cable driver component and then sent out the rear panel BNC.

### *Audio path*

Embedder. The Embedder version of the card has an onboard audio processor that receives a TDM stream containing up to 192 channels of audio and timing information from the system audio crosspoint. These signals are turned into 96 AES pairs, 8 of which are presented to each video channel.

### *Shuffler*

The audio path for the shuffler card is all contained within the FPGA component that processes each video signal. The raw embedded data is simply re-arranged based on control system commands to produce the desired combination of signals at the output.

## **Control**

The 121293-1 card has an onboard microprocessor that manages housekeeping tasks such as measuring current draw and temperature, and acts as the control path for the system Frame Controller module to gather status and make changes to the card.

## Power Supplies

The 121293-1 card receives -48V from the system backplanes and generates 3.3V, 2.5V, 1.8V, and 1.2 V. All voltages are monitored for health and the failure of one of them will result in a dark 'Power Good' LED (DS14).

## Controls And Indicators

### *Controls*

SW1 Dipswitch –

DIP1 when on indicates this card is a 121293-2 Shuffler, when off indicates a 121293-1 embedder. Set by the factory.

DIP2 when on puts the card in audio pass thru mode, when off puts the card in audio mute mode.

Audio pass thru mode means that when the router outputs that control the embedders are switched to off or never controlled, the audio arriving with the video signal is simply passed thru. This mode is useful if you want to replace only a portion of the audio that is already on the video signal. Audio mute mode means that if the router outputs that control the embedders are switched to off or never controlled, the audio on the channels will mute. This mode is suitable for situations where all of the audio channels need to be stripped off of the video signal. The mode can be set on a card by card basis, and controls all 12 outputs on a card.

SW2 Reset switch - Pressing this switch performs a cold reset of the board.

### *Indicators*

DS11 – Green - ON indicates that the audio processor circuit is configured.

DS17 – Green – ON indicates that the embedder / shuffler circuit is configured.

DS1-10, 12, 13 – Green – Output Locked - Video channels 1-12 respectively. ON indicates that the video circuit has locked to the incoming video.

DS14 – Green –POWER GOOD - ON indicates that all supplies are healthy.

DS15- Red – Alarm - ON Indicates that there is a fault with the board. Further diagnostics can be done via the serial port or system monitoring applications.

DS16 – Yellow – Comms - ON indicates that the card is being addressed by the router control system.

## **Specifications**

### *Power Consumption*

22 Watts (.45A of -48V)

### *Output Return Loss*

Less than -15 dB to 1.5 Ghz, Less than -10 dB to 3 Ghz.

### *Output Amplitude*

800mV +- 10%

### *Supported Video Formats*

SMPTE259C – 525 Line and 625 Line

SMPTE292 – 1080i 50/60 Hz, 720P 50/60 Hz

### Rear Panel Connections

All connections are via BNC connector. The card uses the standard BNC IO panel for Series 2 routers. (121226-1)

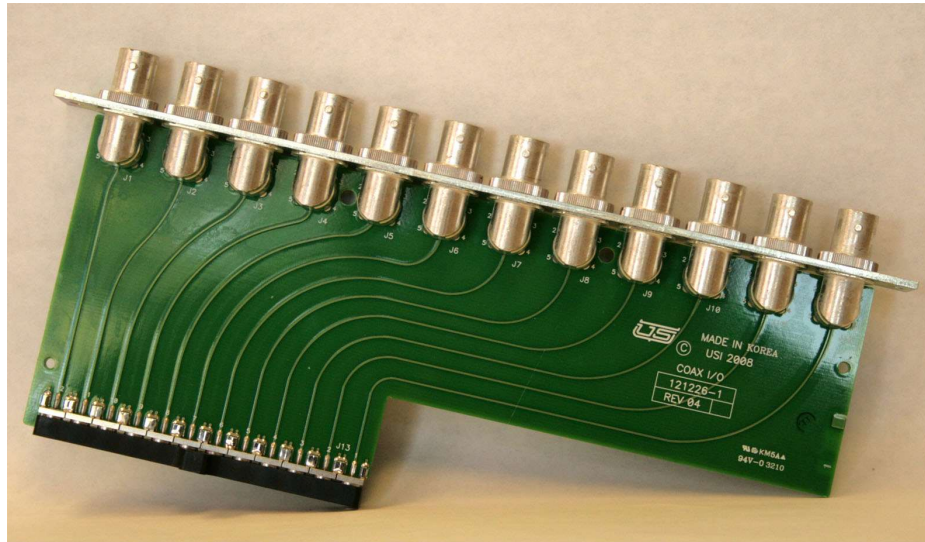

FIGURE 4-17.

---



---

## *UT400 Series 2 Embedding SDI Fiber Output Card – 121405-1*

### **General**

This card serves the same purpose as the standard SDI Output card with the added features of being able to either;

1. Selectively replace the embedded audio with audio signals delivered to this card from a TDM crosspoint, or
2. Shuffle the embedded audio within one video channel to the users requirements.

The distinction between these two functions is based on a different type of firmware loaded in the boards, and a different sub part number. The 121405-1 is the embedder card, and the 121405-2 is the shuffler card.



**FIGURE 4-18.**

Each card has 12 fully independent video channels that allow for different video standards on adjacent channels. Audio timing information, which is only required for the Embedder version of the card, is derived from the TDM stream delivered to the board.

The video path on the card includes a de-serializer – serializer pair that is always enabled in part of the signal path. Regardless of the state of the embedders or shuffler, the delay associated with this serialization / de-serialization is approximately 4 micro seconds. The video data is reclocked within this process, ensuring an output with the lowest possible jitter. The serializer component also includes a differential driver to feed the SFP modules on the rear panel.

All portions of the video path are capable of passing SMPTE 259 and 292 (SMPTE 424 is not supported). Because this path is specific to SMPTE SDI signals, no other signal types can be passed thru this card.

## **Circuit Description**

### *Video Path*

The video signals presented to this card originate at the video crosspoint card in the system. Each video channel has two possible paths, from either the primary or the redundant crosspoint card. The signals arrive as a differential pair from the crosspoint.

The first component they connect to is a reclocking de-serializer component. The output of this part goes to an FPGA component which shuffles or inserts audio channels into the video stream.

From here, the signal is fed into a serializer/cable driver component and then sent out the rear panel BNC.

### *Audio path*

Embedder. The Embedder version of the card has an onboard audio processor that receives a TDM stream containing up to 192 channels of audio and timing information from the system audio crosspoint. These signals are turned into 96 AES pairs, 8 of which are presented to each video channel.

### *Shuffler*

The audio path for the shuffler card is all contained within the FPGA component that process's each video signal. The raw embedded data is simply re-arranged based on control system commands to produce the desired combination of signals at the output.

## **Control**

The 121405-1 card has an onboard microprocessor that manages housekeeping tasks such as measuring current draw and temperature, and acts as the control path for the system Frame Controller module to gather status and make changes to the card.

## Power Supplies

The 121405-1 card receives -48V from the system backplanes and generates 3.3V, 2.5V, 1.8V, and 1.2 V. All voltages are monitored for health and the failure of one of them will result in a dark 'Power Good' LED (DS14).

## Controls And Indicators

### *Controls*

SW1 Dipswitch –

- DIP1 when on indicates this card is a 121405-2 Shuffler, when off indicates a 121405-1 embedder. Set by the factory.
- DIP2 when on puts the card in audio pass thru mode, when off puts the card in audio mute mode.

Audio pass thru mode means that when the router outputs that control the embedders are switched to off or never controlled, the audio arriving with the video signal is simply passed thru. This mode is useful if you want to replace only a portion of the audio that is already on the video signal. Audio mute mode means that if the router outputs that control the embedders are switched to off or never controlled, the audio on the channels will mute. This mode is suitable for situations where all of the audio channels need to be stripped off of the video signal. The mode can be set on a card by card basis, and controls all 12 outputs on a card.

SW2 Reset switch - Pressing this switch performs a cold reset of the board.

### *Indicators*

DS11 – Green - ON indicates that the audio processor circuit is configured.

DS17 – Green – ON indicates that the embedder / shuffler circuit is configured.

DS1-10, 12, 13 – Green – Output Locked - Video channels 1-12 respectively. ON indicates that the video circuit has locked to the incoming video.

DS14 – Green –POWER GOOD - ON indicates that all supplies are healthy.

DS15- Red – Alarm - ON Indicates that there is a fault with the board. Further diagnostics can be done via the serial port or system monitoring applications.

DS16 – Yellow – Comms - ON indicates that the card is being addressed by the router control system.

## Specifications

### *Power Consumption*

- 30 Watts (.62A of -48V) with 6 Digital Dual Rx Digital Optical Receiver installed in rear panel
- 800mV +- 10%
- Supported Video Formats
- SMPTE259C – 525 Line and 625 Line
- SMPTE292 – 1080i 50/60 Hz, 720P 50/60 Hz

## Rear Panel Connections

The card uses the standard Fiber IO panel for series 2 routers. (121232-1)



FIGURE 4-19.

---

## *UT400 Series 2 Triple Port MADI IO Card – 121320-1/2*

### **General**

This card is used to either receive (121320-1) or transmit (121320-2) 3 unique AES-10 (MADI) multichannel audio signals containing 64 channel of audio each. It is used to interconnect devices like Audio Consoles to the TDM audio matrix, or to act as a concentrator where Utah Scientific MADI transceiver systems interconnect.

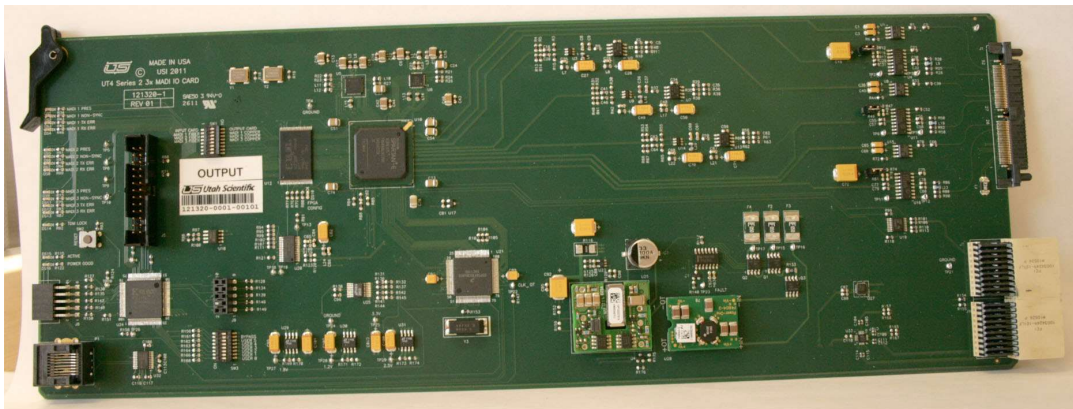

**FIGURE 4-20.**

The internal audio connections are solely tied to the TDM audio crosspoint, no XY crosspoint based signals are provided by this board.

The input card can utilize either fiber or copper MADI connections. The fiber interconnect is via an NON-MSA dual receive SFP module on the rear panel, and is an option.

The output version provides copper and fiber outputs simultaneously, with the fiber outputs being driver by NON-MSA dual transmit SFP modules.

### **Circuit Description**

#### *Input card (121320-1)*

This module occupies one slot in the input side of a TDM enabled UT400 Series 2 router. The input signals are selected as being either copper or fiber for each of the three channels individually.

Once the fiber type is determined, each of the three MAD I receive circuits locks to and recovers the 64 audio signals from the MAD I stream. Status of the incoming streams is indicated on LED's on the board front edge. These signals are combined with the ones from the other two channels and then presented to a serializer.

The serializer generates an approximately 700 Mb/Sec signal that combines all of the audio channels and system timing information, which is delivered to this card from the system FCM module.

The resultant signal is presented to a 1:4 fanout device to drive the signal to the four possible crosspoint slots in the system.

### *Output card (121320-2)*

This card is very similar to the 121230-1, with just a few resistor positions populated differently. It operates in the reverse of the -1 board, with the signal path originating from a de-serializer component that receives a 192 channel TDM audio stream from the system crosspoints.

Once this stream is received, it is decoded into its 192 channels of audio, and these are presented to MAD I transmitter circuits.

The MAD I signals are then driven out of their individual channels, one copper via a SMPTE compliant cable driver, and one fiber via an SFP module.

The 121320-x card has an onboard microprocessor that manages housekeeping tasks as measuring current draw and temperature, and acts as the control path for the system Frame Controller module to gather status and make changes to the card.

### *Power Supplies*

The 121320-x card receives -48V from the system backplanes and generates 3.3V, 2.5V, and 1.2 V. All voltages are monitored for health and the failure of one of them will result dark 'Power Good' LED (DS16).

## **Controls And Indicators**

### *Controls*

SW1 Dipswitch – Used to set board personality, and to determine if inputs arrive via Fiber or copper.

DIP1 - Input card or output card selection. Move the dipswitch to the ON position for output or the other direction for an input card.

DIP2 – Not used for an output card. For an input card, this controls the source for the first MAD1 port.

Move the switch to the ON position for a copper input, or the other direction for a fiber input

DIP3 – Not used for an output card. For an input card, this controls the source for the second MAD1 port.

Move the switch to the ON position for a copper input, or the other direction for a fiber input

DIP4 – Not used for an output card. For an input card, this controls the source for the third MAD1 port.

Move the switch to the ON position for a copper input, or the other direction for a fiber input

DIP8 – Not used for an input card. This switch controls insertion of AES channel status information into the outgoing MAD1 streams in an output card.

Move the switch to the ON position to not pass channel status, or the other direction to allow the card to pass thru channel status information.

SW2 Reset switch - Pressing this switch performs a cold reset of the board.

SW3 Dipswitch – Used for card programming, no user adjustments.

### *Indicators*

DS1- DS4 – MAD1 Channel 1 indicators. These LED's indicate presence of a MAD1 input or output, non-synchronicity of the MAD1 input, MAD1 receive errors and MAD1 transmit errors respectively. An on state indicates that the status is active.

DS5-DS8 – MAD1 Channel; 2 indicators.

DS9, DS11-DS13 - MAD1 Channel 3 indicators

DS14 – TDM LOCK – Indicates that the card has locked to the TDM stream coming from the crosspoint card (input) or is generating that stream (output).

DS10 – FPGA CONFIG – Indicates that the on board FPGA is configured.

DS15 – Yellow – Indicates that the card is being accessed by the chassis control system.

DS16 – Green – Indicates that the board power system is OK.



## Specifications

### *Power Consumption*

8 Watts (.12A of -48V)

### *Output Return Loss*

Less than -15 dB to 125MHz.

### *Output Amplitude*

800mV +- 10%

## Rear Panel Connections

Both the 121320-1 and -2 cards use the 121324-1 3X MADI rear panel for connectivity to external signals.

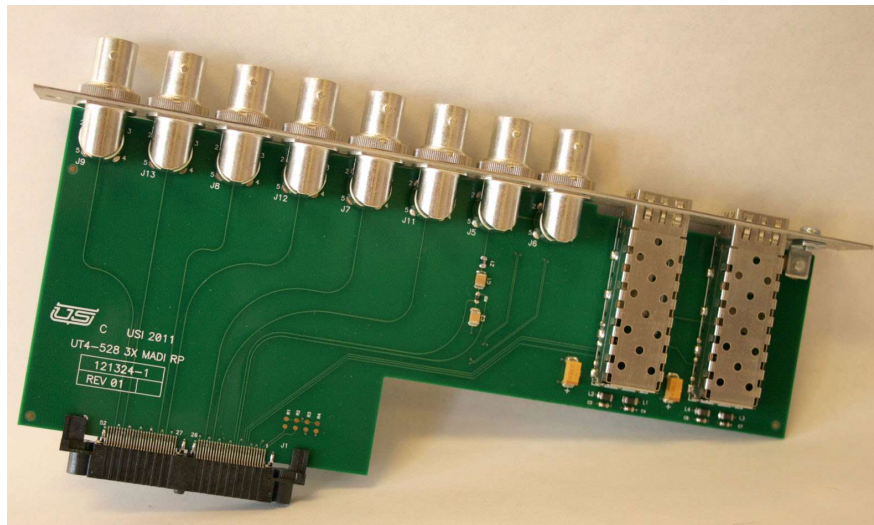

FIGURE 4-21.

---

---

## Utah-400 Components

---

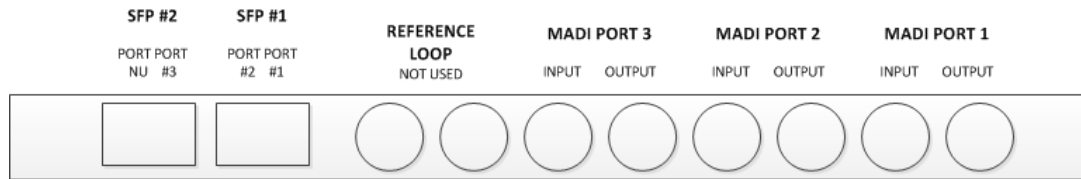

## Serial Diagnostic Port Commands

Under Development

## UT400 Series 2 12 Port TDM Crosspoint Submodule – 121295-1

### General

This submodule creates a 2304x2304 monaural audio TDM matrix. Its interfaces are 12 TDM audio input streams, each carrying 192 channels of audio, 12 TDM audio output streams carrying 192 channels of audio, and a 20 bit control bus to control which inputs are switched to which outputs.

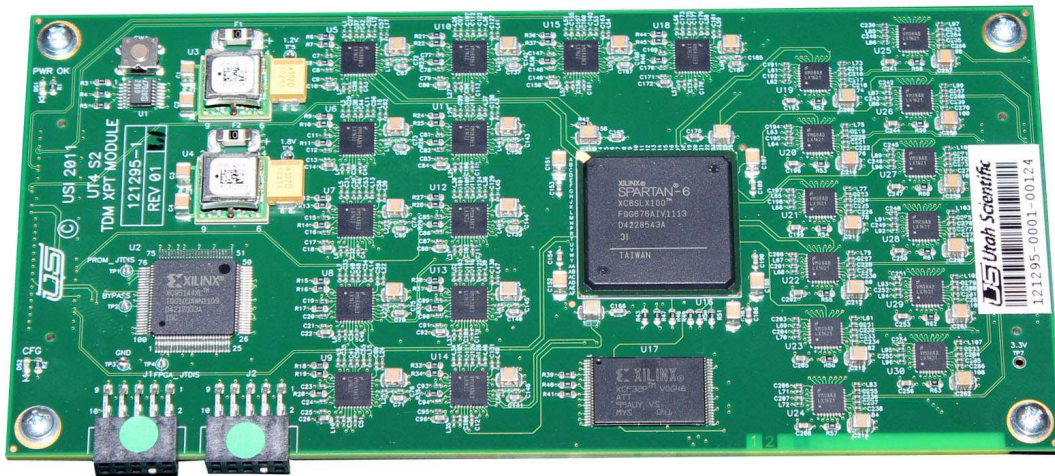

FIGURE 4-22.

The submodule plugs onto one of 3 different carrier cards. The 121242-1 Series 2 144x144 crosspoint card, the 121248-1 Series 2 288x288 crosspoint card, or in one of four locations on the 121323-1 528 router Audio Crosspoint carrier.

### Circuit Description

#### Audio Path

The inputs to this assembly are 192 channel TDM links that originate in the input card slots in the router matrix. Each input channel is presented to a deserializer component that convert the signal to a clock and 16 bit data bus carrying audio.

This deserialized data structure is then presented to an FPGA that is programmed to instantiate 16 different 144x144 crosspoints, each active at the proper moment in time to implement their section of the 2304 x2304 matrix.

The result of the crosspoint action is 12 unique instances of 16 data bits and a clock that make up the proper signaling for each of 12 output card slots. Each of these groups is presented to a serializer component that carry's the data to the appropriate output card.

### *Control*

In each location where this submodule is used, an on board MX-BUS decoder converts control commands coming over the MX bus into the proper format, and then presents the commands to the control inputs of this card.

### *Power Supplies*

This board is fed 3.3V from the carrier card it is installed in, and generates onboard 1.8V and 1.2V voltages.

### *Controls And Indicators*

No Controls

DS1 – Green – Power OK. On indicates that all voltages are OK.

DS2 – Green – Config. On indicates the board is configured and operating normally.

---

## *UT400 Series 2 528 Frame TDM Crosspoint Carrier – 121323-1*

### **General**

This assembly occupies a crosspoint slot in a Series 2 528 style router. It consists of a carrier for four of the 121295-1 TDM Crosspoint submodules, and works along side video crosspoint cars in the 528 system to create a combined TDM audio / Video switching matrix.

It can only be located in slots 0 or 2 of the 528 frame.

This card supports TDM connections from input slots 0-11 and output slots 22-34 in the 528 system.

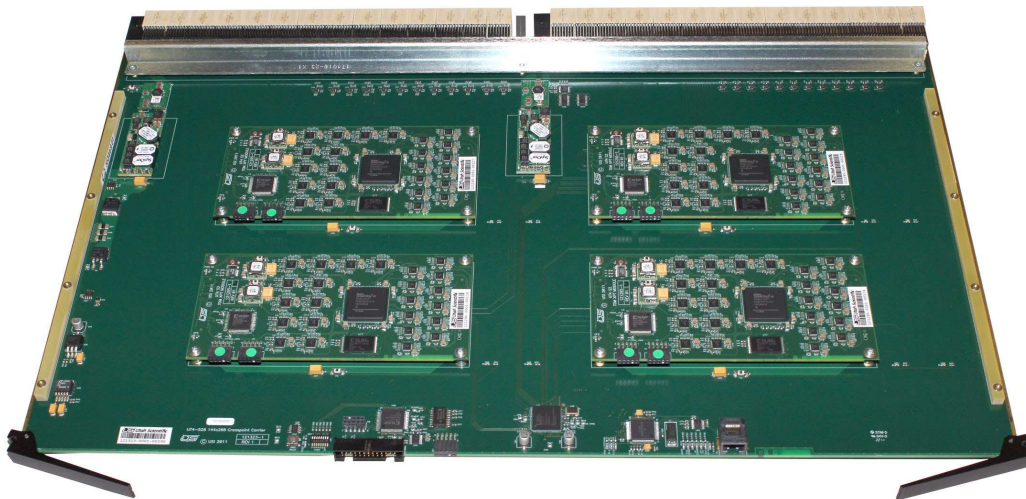

**FIGURE 4-23.**

### **Circuit Description**

Each TDM signal is buffered thru a 1:4 fanout DA and presented to each of the four 121295-1 submodules on the board.

The first three output channels of each 121295-1 submodule are used to create the 12 required streams to service the 12 output card slots.

### Controls And Indicators

SW2 is a reset switch which will perform a restart of all logic on the board.

SW1 is used for programming functions.

DS10 – FPGA Load – Green - Illuminated when the FPGA is configured. If it is off, the card is not functional.

DS11 – PSA FAIL – RED - Illuminated when the 'A' 48V to 3.3V converter is non-functional.

DS12 – PSBA FAIL – RED - Illuminated when the 'B' 48V to 3.3V converter is nonfunctional.

DS13 – Health – RED – Illuminated when the internal monitoring circuit detects ANY non-ideal conditions on the card.

DS14 – FCM COM – Yellow – Illuminated when this card is selected by the Frame Communication Module

DS16 – XP-COMMS – Green –Indicates that all submodule communication is good.

DS17 – XP-PSOK – Green – Illuminated when all PS sub module power supplies are OK.

DS18 – SEAT – Green – Illuminated when all rear panel sampling points are satisfied, indicating that the crosspoint card is seated properly.

DS19 – SG Activity – Indicates that the local Scangate part is active.

DS1-8 – No currently used

DS9 – Illuminated if the board is in a reset condition.

Serial Diagnostic Port Commands

Under Development

## *UT4-528 Standard Digital Audio Input with TDM Board – 121288-1*

### **General**

The Standard Digital Audio Input with TDM Board (121288-1) receives 12 AES3 audio signals. These signals are received and individually analyzed to see if they qualify for synchronization to the digital audio reference (DARS). In its standard form DARS is an AES3, 48 kHz signal with sample and frame rate information. These input boards provide a TDM stream and 12 separate AES3 signals to the system xpoint for routing. The TDM stream must have input signals that are synchronous to the 48 kHz DARS reference. Asynchronous audio signals will not be passed to the system xpoint thru the TDM stream. The 12 separate AES3 signals can be passed to the xpoint both synchronously and asynchronously.

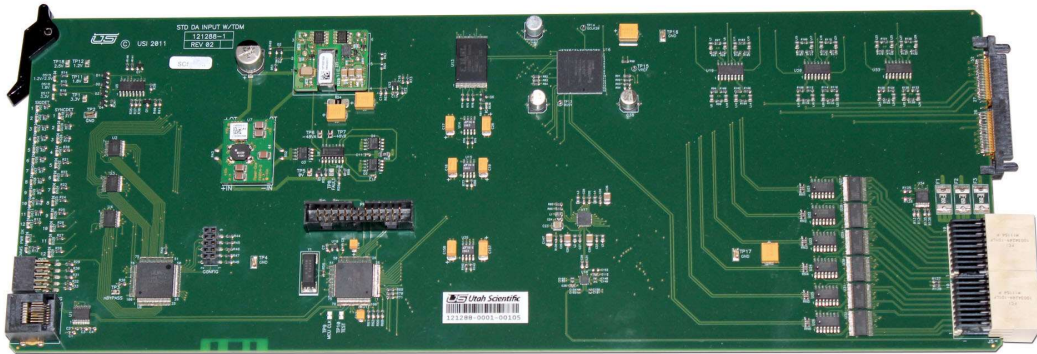

FIGURE 4-24.

### **Circuit Description**

The digital audio input signals arrive as differential pairs and are converted to single ended signals. They are then presented to an FPGA that receives the AES3 inputs and pulls them apart and separates the clocks, data, and status bit information. This audio payload is evaluated and if it qualifies for synchronization, it is realigned with clock and sync signals derived from the DARS input.

The separated signals are converted back into AES3 and passed to the system xpoint in two methods. One method includes individually passing the 12 AES3 signals to the system xpoint

and the other method includes a single TDM stream that carries all 12 inputs information. The system xpoint will determine whether it uses the TDM or Non-TDM inputs. AES3 inputs must be synchronous to the DARS input in order for the TDM stream to accurately represent the input signals. The Non-TDM inputs will pass as synchronous or if they are substantially offset from the DARS input will be passed through the router asynchronously.

### **Controls and Indicators**

There are no controls on this card, other than P1. This is a standard UT400 diagnostic port that provides detailed operational status and control for this card.

There are five types of LED indicators present on the front edge on this card

1. COMMS -> Communications indicator (yellow). Illuminated when the Frame Controller Module addresses this card.
2. PWR OK -> Power supply indicator (green). Illuminated when the local power supplies are within tolerance.
3. SIGDET1-12 -> Signal detection LEDs (green). Illuminated when a valid digital audio signal is detected on the associated receiver input.
4. SYNCDET1-12 -> Sync detection LEDs (yellow). Illuminated when a valid input signal is found to be in sync with the router reference and is being processed accordingly.
5. 1.2V, 2.5V, and 3.3V -> Power supply fail indicators (red). Illuminated when local voltages fall out of 5% tolerance.



## Serial Diagnostic Port Commands

121288-1

-----  
Menu-

V = Version  
S = Hardware Status  
F = Fiber Module Status

'V' -

\*\*\*\*\*  
                  Utah Scientific Inc.  
                  UT400-528 IO CD Monitor R3.06  
\*\*\*\*\*

'S' -

STATUS REPORT  
Power Used = 2 w.                  (Board Power Used)  
Board Temp = 24 C.                 (Board Temperature)  
Board PN = 1288-1020                (Board Part Number)  
Board SN = 0116                     (Board Serial Number)  
SGBuild Date = 01/09/0C             (Build Date)  
Slot Address = 00                    (Slot Address)  
Board Type = AES Input w-TDM        (Board Type Description)  
FW Version = 0302                    (FPGA Firmware Version)  
Semaphore = 1234                     (FPGA Semaphore)  
Ref OK = 01                          (DARS Reference Indication)  
Sig Det 12-1 = 1                     (Signal Detection - bits 12-1)  
Sync Det 12-1 = 1                    (Sync Detection - bits 12-1)

'F' -

Fiber Status

### Rear Panel Connections

There are currently two rear panels available for this audio interface.

UT4-S2 DA Balanced Input Rear Panel (121237-1 -> D-SUB 37)

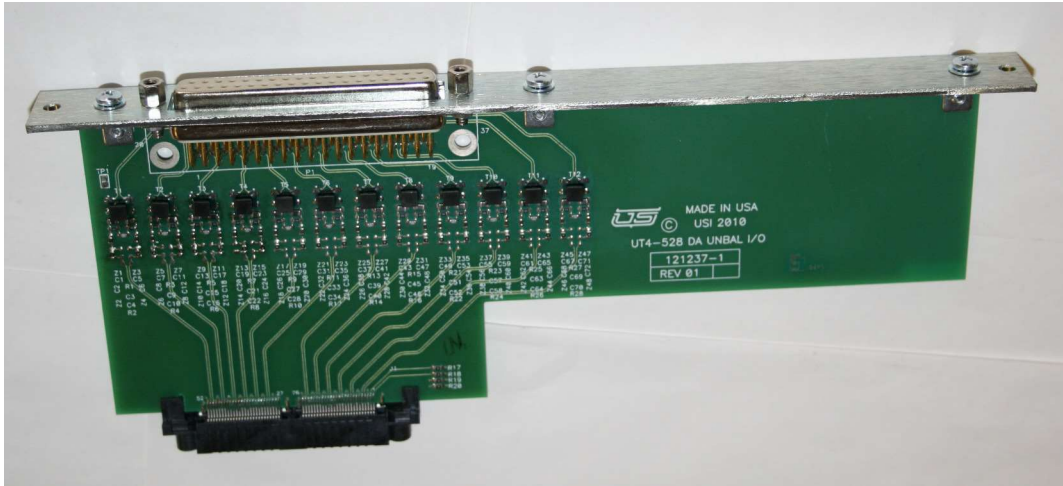

FIGURE 4-25.

Rear Panel Pinout (D-Sub 37) 121237-1

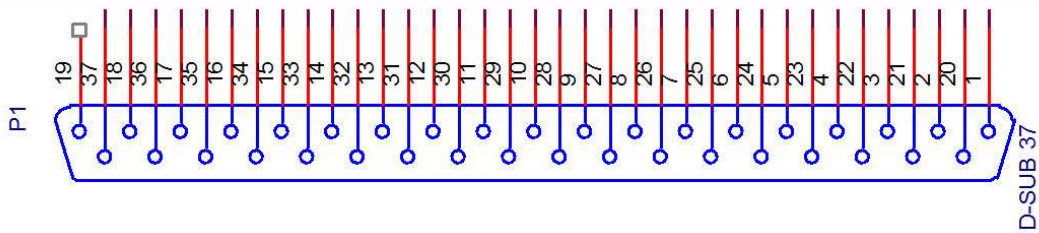

TABLE 1.

1	IOC2	19	
2	IOB2	20	IOC1
3	IOA2	21	IOA1

**TABLE 1.**

4	IOB3	22	IOB1
5	IOA3	23	IOC3
6	IOB4	24	IOC4
7	IOA4	25	IOA0
8	IOB5	26	IOB0
9	IOA5	27	IOC0
10	IOB6	28	IOC5
11	IOA6	29	IOC6
12	IOB7	30	IOC7
13	IOA7	31	IOA11
14	IOB8	32	IOB11
15	IOA8	33	IOC11
16	IOB9	34	IOC8
17	IOA9	35	IOA10
18	IOC9	36	IOB10
		37	IOC10

- Audio Connectors

Description	UTSCI #	Manufacturer	Part #
Con. D-32P M Solder	41226-2037	AMPHENOL	L717SDC37P
Con-Hood Univ 37P	41231-0037	AMPHENOL	17DTZK37K

- Digital Audio Breakout Panel (140023-0004) - This is an optional I/O interface converting d-sub's to terminal blocks. See Appendix C for more information.

### 121245-1 Rear Panel Layout (BNC)

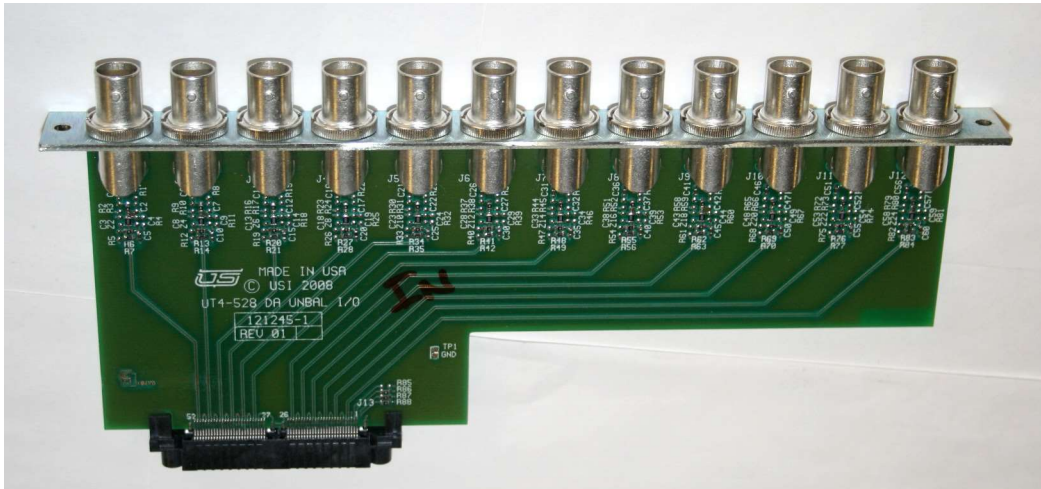

FIGURE 4-26.

### Specifications

Power Consumption – 2 Watts (.05A of -48V)

Unbalanced BNC Cable Interfaces – 75 Ohm, up to 300 meters (Recommended – Belden 8281 or better.)

Balanced D-SUB 37 Cable Interface – 12 pair/24 AWG/Stranded, up to 100 meters (Recommended – Belden 9993 or better.)

Audio Format – 48 kHz. 16 - 24 Bit, AES / EBU; AES-3

## *UT4-528 Standard Digital Audio Output with TDM Board – 121289-1*

### **General**

The Standard Digital Audio Output Board with TDM (121289-1) receives 12 AES3 digital audio signals or receives a single TDM stream from the appropriate xpoint boards. These signals are individually driven to the monitor matrix module and router output panels. These signals pass through the output card as unmanipulated AES3 digital audio.

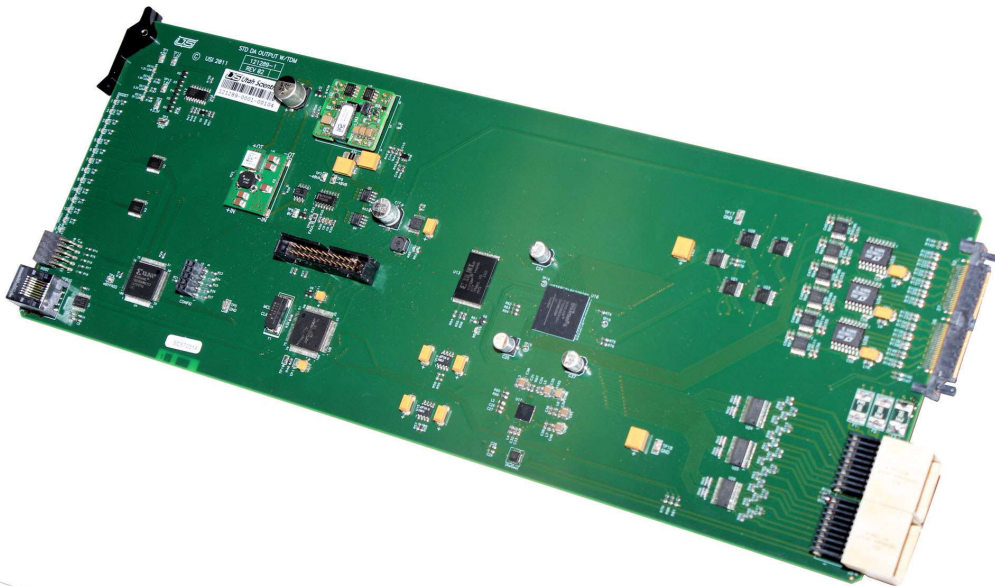

FIGURE 4-27.

### **Circuit Description**

The 12 digital audio signals arrive at the output card from corresponding xpoint boards as differential signals or they arrive from the TDM xpoint board as a single TDM stream. When a TDM stream is presented to the output board a deserializer separates the 12 signals and passes them to the FPGA for routing. When there is no TDM stream present the mode changes to Non-TDM and the 12 signals are passed directly to the FPGA for routing.

The FPGA determines whether to route the TDM or Non-TDM signals to the output drivers; there, it is converted into two differential pairs of AES3 audio. One pair is passed to the monitor matrix circuit where one of the twelve outputs is routed to the monitor matrix output. The second pair is driven to the output rear panel.

### **Controls and Indicators**

There are no controls on this card, other than P1. This is a standard UT400 diagnostic port that provides detailed operational status and control for this card.

There are four types of LED indicators present on the front edge on this card

1. PWR OK -> Power supply indicator (green). Illuminated when the local power supplies are within tolerance.
2. COMMS -> Communications indicator (yellow). Illuminated when the Frame Controller Module addresses this card
3. SIGDET1-12 -> Signal detection LEDs (green). Illuminated when a valid digital signal (relatively close to 48kHz frame rate) is detected on the associated output driver.

***Note: MADI, ADC, and TDM inputs to this board provide a 'no audio' AES signal. This will illuminate the signal detect LEDs when switched up to these outputs.***

4. 1.2V, 1.8V, 3.3V and 5V -> Power supply fail indicators (red). Illuminated when local voltages fall out of 10% tolerance.

### Rear Panel Connections

There are currently two rear panels available for this audio interface.

UT4-S2 DA Balanced Output Rear Panel (121237-2 -> D-SUB 37)

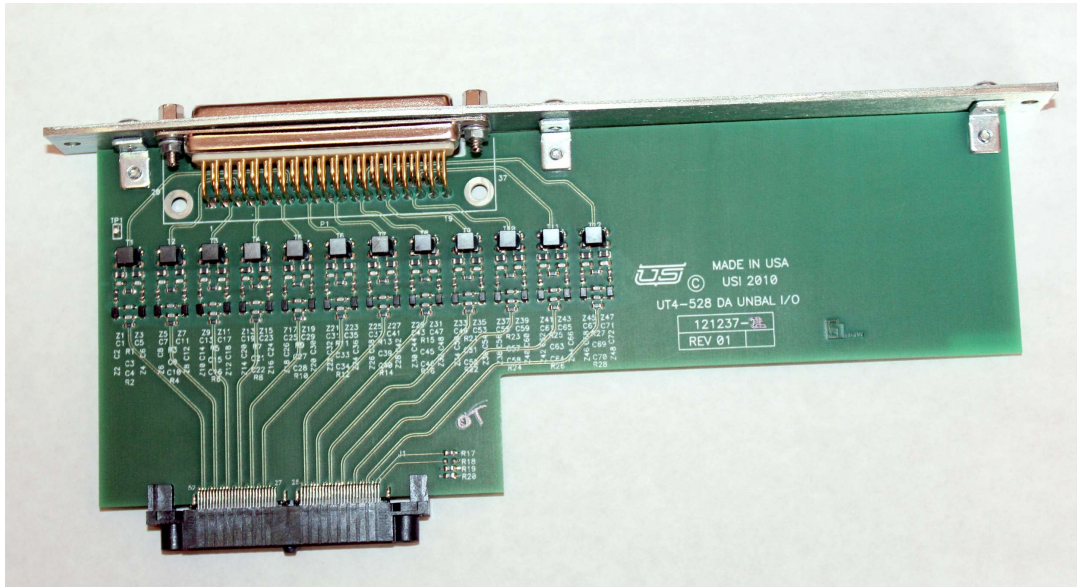

FIGURE 4-28.

---

Rear Panel Pinout (D-Sub 37) - 121237-2

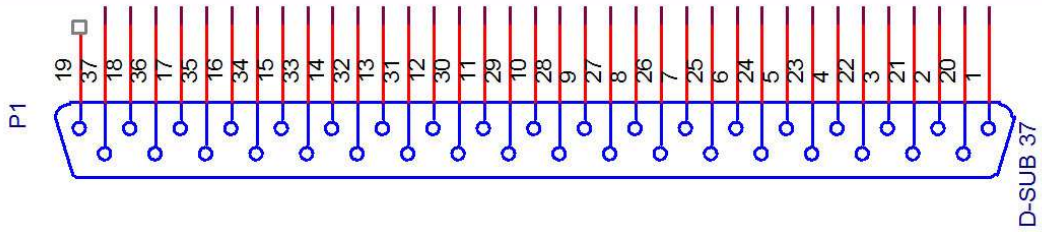

TABLE 2.

1	IOC2	19	
2	IOB2	20	IOC1
3	IOA2	21	IOA1
4	IOB3	22	IOB1
5	IOA3	23	IOC3
6	IOB4	24	IOC4
7	IOA4	25	IOA0
8	IOB5	26	IOB0
9	IOA5	27	IOC0
10	IOB6	28	IOC5
11	IOA6	29	IOC6
12	IOB7	30	IOC7
13	IOA7	31	IOA11
14	IOB8	32	IOB11
15	IOA8	33	IOC11
16	IOB9	34	IOC8
17	IOA9	35	IOA10
18	IOC9	36	IOB10
		37	IOC10



- Audio Connectors

Description	UTSCI #	Manufacturer	Part #
Con. D-32P M Solder	41226-2037	AMPHENOL	L717SDC37P
Con-Hood Univ 37P	41231-0037	AMPHENOL	17DTZK37K

Digital Audio Breakout Panel (140023-0004) - This is an optional I/O interface converting d-sub to terminal blocks. See Appendix C for more information.

UT4-S2 DA Unbalanced Output Rear Panel (121245-2 -> BNC)

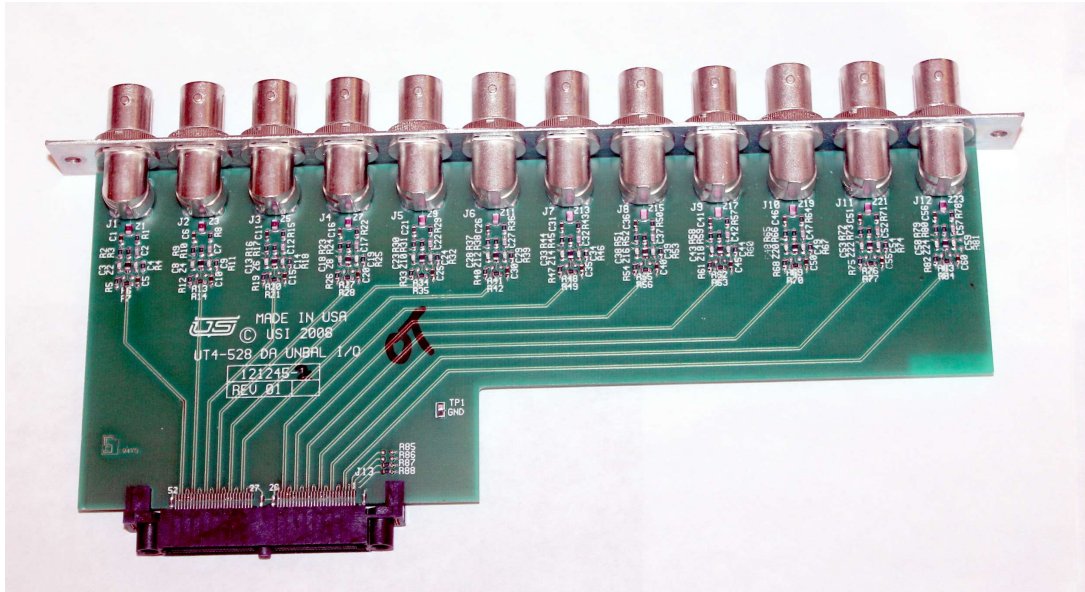

FIGURE 4-29.

### **Specifications**

Power Consumption – 5 Watts (.1A of -48V)

Unbalanced BNC Cable Interfaces – 75 Ohm, up to 300 meters (Recommended – Belden 8281 or better.)

Balanced D-SUB 37 Cable Interface – 12 pair/24 AWG/Stranded, up to 100 meters (Recommended – Belden 9993 or better.)

Audio Format – 48 kHz. 16 - 24 Bit, AES / EBU; AES-3

## Serial Diagnostic Port Commands

```
121289-1
-----
Menu-
V = Version
S = Hardware Status
F = Fiber Module Status

'V'-
*****
      Utah Scientific Inc.
      UT400-528 IO CD Monitor R3.06
*****

'S'-
STATUS REPORT
Power Used = 4 w.           (Board Power Used)
Board Temp = 24 C.         (Board Temperature)
Board PN   = 1289-1020     (Board Part Number)
Board SN   = 0110          (Board Serial Number)
SGBuild Date = 01/09/0C   (Build Date)
Slot Address = 00          (Slot Address)
Board Type = AES output w-TDM (Board Type Description)
Fw Version = 0202          (FPGA Firmware Version)
Semaphore = 1234           (FPGA Semaphore)
TDM Lock = 01              (TDM Circuit Locked)
XP_SEL_R/P = 00            (Xpoint Select Redundant/Primary)
Sig Det 12-1 = fff         (Signal Detection - bits 12-1)
TDM ch1 12-1 = 1           (TDM CH1 Signal Detection - bits 12-1)
TDM ch2 12-1 = 0           (TDM CH2 Signal Detection - bits 12-1)
MMX Output = 00            (Monitor Matrix Output)

'F'-
Fiber Status
```

## *UT4-528 Digital Audio Digital to Analog (DAC) Output with TDM Board – 121326-1*

### **General**

The Digital Audio DAC Output Board with TDM (121326-1) receives 12 AES3 digital audio signals or receives a single TDM stream from the appropriate xpoint board. These signals are individually distributed to the digital to analog converter outputs and the monitor matrix module. The converted analog audio is then driven to the router output panels. The signal passed to the monitor matrix module will be the AES3 digital audio before it is converted into analog.

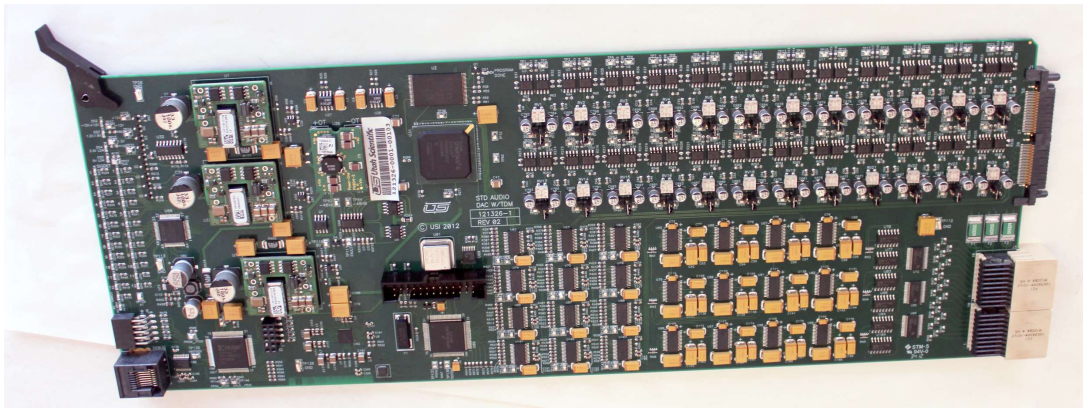

**FIGURE 4-30.**

### **Circuit Description**

The 12 digital audio signals arrive at the output card from corresponding xpoint boards as differential signals or they arrive from the TDM xpoint board as a single TDM stream. When a TDM stream is presented to the output board a deserializer separates the 12 signals and passes them to the FPGA for routing. When there is no TDM stream present the mode changes to Non-TDM and the 12 signals are passed directly to the FPGA for routing. The FPGA determines whether to route the TDM or Non-TDM signals to the output drivers; there, it is converted into two differential pairs of AES3 audio. One pair is passed to the monitor matrix circuit where one of the twelve outputs is routed to the monitor matrix output. The second pair is driven to the digital to analog converter circuit and then output to the rear panel.

## Controls and Indicators

There are no controls on this card, other than P1. This is a standard UT400 diagnostic port that provides detailed operational status and control for this card.

There are four types of LED indicators present on the front edge on this card

1. PWR OK -> Power supply indicator (green). Illuminated when the local power supplies are within tolerance.
2. COMMS -> Communications indicator (yellow). Illuminated when the Frame Controller Module addresses this card.
3. SIGDET(L/R)1-12 -> Signal detection LEDs (green). Illuminated when a valid digital signal is detected on the associated output driver.

**Note #1: (Non-TDM mode) The MAD1 and ADC inputs to this board provide a 'no audio' AES signal, which will illuminate the signal detect LEDs when switched to these outputs.**

**Note #2: In TDM mode, an audio signal level approximately  $< .1V$  will not illuminate a signal detect LED.**

4. 1.2V, 1.8V, 3.3V, 5VA, 12V and -12V -> Power supply fail indicators (red). Illuminated when local voltages fall out of 10% tolerance.

This board will drive high impedance loads (e.g. 100k ohm – no jumper). In instances when a 600 ohm load needs to be driven, this board is supplied with jumpers on each channel that when installed provide the appropriate level adjustment.

Rear Panel Layout (2xD-Sub 37).

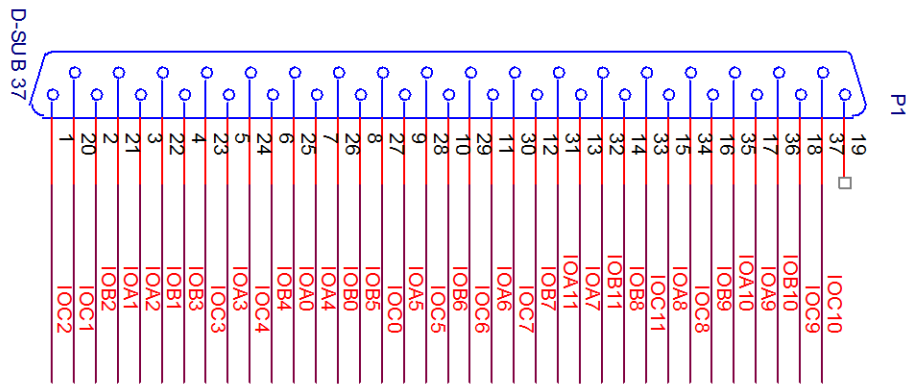

FIGURE 4-31.



FIGURE 4-32. Channel B = Right, Channel A = Left

IO = Input or Output use

A = Positive

B = Negative

C = shield/ground

0 - 11 = Input or output physical number.

**Note: 0 - 11 represents the first card slot. In this sequence, the next card slot is 12 - 23, the 3rd slot is 24 - 35, etc.**

## Specifications

- Power Consumption – 15 Watts (.3A of -48V)
- Analog 2xD-SUB 37 Cable Interface – 12 pair/24 AWG/Stranded (Recommended – Belden 9993 or better.)
- Audio Format – Professional Audio, 48 kHz, 24 Bit, AES / EBU; AES-3
- Analog Specifications:
  - Frequency Response=20-20kHz +/- .05dB
  - Max Output Level=24dBu
  - Output Impedance =20 ohm differential
  - THD @ 24dBu, 20-20kHz=.05%
  - IMD @ 24dBu, 20-20kHz=.05%
  - Hum and Noise, 20-15kHz=-85dBu
  - Crosstalk @ 20kHz=-90dB
  - Gain Uniformity=+/- .05dB

### Rear Panel Connections

- UT4-S2 DA Analog Rear Panel (121327-1 -> 2xD-SUB 37)
- Audio Connectors

Description	USI#	Manufacturer	Part#
Con. D-37P M Solder	41226-2037	AMPHENOL	L717SDC37P
Con-Hood Univ 37P	41231-0037	AMPHENOL	17DTZK37K

- Digital Audio Breakout Panel (140023-0004) – This is an optional I/O interface converting d-sub to terminal blocks. See Appendix C for more information.



## Serial Diagnostic Port Commands

```
121326-1
-----
Menu-
V = Version
S = Hardware Status
F = Fiber Module Status

'V'-
*****
      Utah Scientific Inc.
      UT400-528 IO CD Monitor R3.06
*****

'S'-
STATUS REPORT
Power Used = 16 W.           (Board Power Used)
Board Temp = 30 C.          (Board Temperature)
Board PN   = 1326-1020      (Board Part Number)
Board SN   = 0111           (Board Serial Number)
SGBuild Date = 09/18/0C    (Build Date)
Slot Address = 02           (Slot Address)
Board Type = DAC Output w-TDM (Board Type Description)
FW Version = 0102           (FPGA Firmware Version)
Semaphore = 1234           (FPGA Semaphore)
TDM Lock = 01              (TDM Circuit Locked)
XP_SEL_R/P = 00            (Xpoint Select Redundant/Primary)
Sig Det 12-1 = 1           (Signal Detection - bits 12-1)
TDM Ch1 12-1 = 1           (TDM CH1 Signal Detection - bits 12-1)
TDM Ch2 12-1 = 0           (TDM CH2 Signal Detection - bits 12-1)
MMX output = 00            (Monitor Matrix Output)

'F'-
Fiber Status
```

## *UT4-528 Digital Audio Analog to Digital (ADC) Input with TDM Board – 121325-1*

### **General**

The Digital Audio ADC Input with TDM Board (121325-1) receives 12 L/R analog signals. These signals are received and individually converted into AES3 signals that are aligned to the digital audio reference (DARS). In its standard form DARS is an AES3, 48 kHz signal with sample and frame rate information. These input boards provide a TDM stream and 12 separate AES3 signals to the system xpoint for routing.

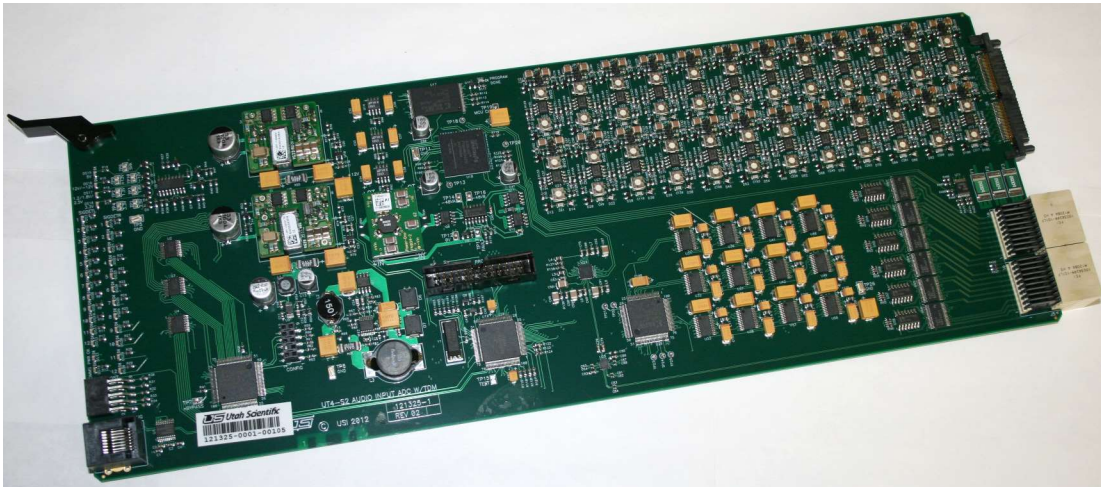

FIGURE 4-33.

### **Circuit Description**

The analog audio input signals arrive as differential pairs and are sampled and converted into data. They are then presented to an FPGA that evaluates and aligns them with clock and sync signals derived from the DARS input. If there is no DARS present, the input signals will be sampled at 48kHz and the audio data will be aligned using the fallback oscillator. The audio payload is converted back into AES3 and passed to the system xpoint in two methods. One method includes individually passing the 12 AES3 signals to the system xpoint and the other method includes a single TDM stream that carries all 12 inputs information. The system xpoint will determine whether it uses the TDM or Non-TDM inputs.

## Controls and Indicators

There are no controls on this card, other than P1. This is a standard UT400 diagnostic port that provides detailed operational status and control for this card.

There are four types of LED indicators present on the front edge on this card

1. COMMS -> Communications indicator (yellow). Illuminated when the Frame Controller Module addresses this card.
2. PWR OK -> Power supply indicator (green). Illuminated when the local power supplies are within tolerance.
3. SIGDET(L/R)1-12 -> Signal detection LEDs (green). Illuminated when a non-silent audio signal is detected on the associated receiver input.
4. 1.2V, 1.8V, 2.5V, 3.3V, 5VA, 12V, and -12V -> Power supply fail indicators (red). Illuminated when local voltages fall out of 5% tolerance.

Rear Panel Pinout (2xD-Sub 37).

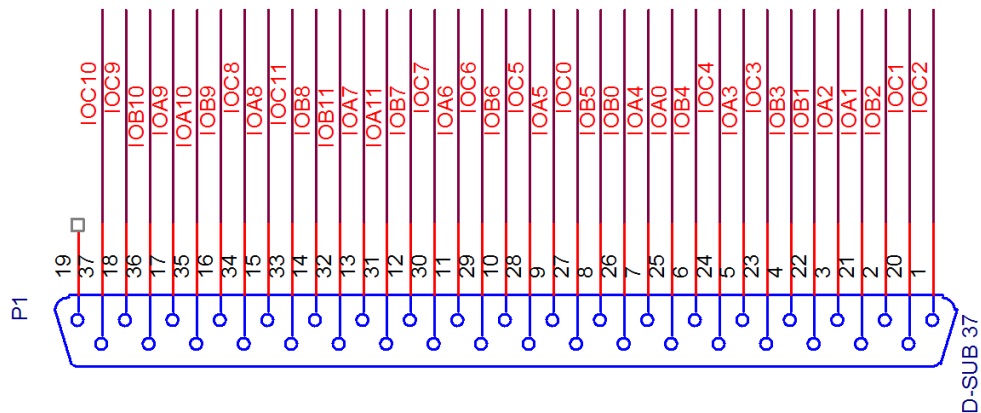

FIGURE 4-34. Channel B = Right, Channel A = Left

IO = Input or Output use

A = Positive

B = Negative

C = shield/ground

0 - 11 = Input or output physical number.

**Note: 0 - 11 represents the first card slot. In this sequence, the next card slot is 12 - 23, the 3rd slot is 24 - 35, etc.**

### Specifications

- Power Consumption – 11 Watts (.2A of -48V)
- Analog 2xD-SUB 37 Cable Interface – 12 pair/24 AWG/Stranded (Recommended – Belden 9993 or better.)
- Audio Format – Professional Audio, 48 kHz, 24 Bit, AES / EBU; AES-3
- Analog Specifications:
  - Frequency Response=20-20kHz +- .05dB
  - Max Input Level=24dBu
  - Input Impedance =200k ohm, strappable to 600 ohm
  - THD @ 24dBu, 20-20kHz=.05%
  - IMD @ 24dBu, 20-20kHz=.05%
  - Hum and Noise, 20-15kHz=-85dBu
  - Crosstalk @ 20kHz=-90dB
  - Gain Uniformity=+- .05dB
  - CMR @50/60Hz= 70 dB

### Rear Panel Connections

- UT4-S2 DA Analog Rear Panel (121327-1 -> 2xD-SUB 37)
- Audio Connectors

Description	USI#	Manufacturer	Part#
Con. D-37P M Solder	41226-2037	AMPHENOL	L717SDC37P
Con-Hood Univ 37P	41231-0037	AMPHENOL	17DTZK37K

- Digital Audio Breakout Panel (140023-0004) – This is an optional I/O interface converting d-sub5 to terminal blocks. See Appendix C for more information.

### Serial Diagnostic Port Commands

121325-1

-----  
Menu-

V = Version  
S = Hardware Status  
F = Fiber Module Status

'V'-

```
*****  
                Utah Scientific Inc.  
            UT400-528 IO CD Monitor R3.06  
*****
```

'S'-

```
STATUS REPORT  
Power Used   = 10 w.           (Board Power Used)  
Board Temp   = 31 C.           (Board Temperature)  
Board PN     = 1325-1020       (Board Part Number)  
Board SN     = 0106            (Board Serial Number)  
SGBuild Date = 09/04/0C       (Build Date)  
Slot Address = 01              (Slot Address)  
Board Type   = ADC Input w-TDM (Board Type Description)  
FW Version   = 0100            (FPGA Firmware Version)  
Semaphore    = 1234           (FPGA Semaphore)  
Ref OK       = 01              (DARS Reference Indication)  
Sig DetL 12-1= 1              (Left Signal Detection - bits 12-1)  
Sig DetR 12-1= 0              (Right Signal Detection - bits 12-1)
```

'F'-

Fiber Status

---

## 72x72 AV Router Components

### Crosspoint Card - 121337-1

#### General

The 72x72 Video Crosspoint card is used exclusively in the 4U 72x72 video routing switcher chassis in the UTAH-400 Series 2 routing switcher family. This frame provides a compact housing for any of the IO cards that comprise the UT400 Series 2 line.

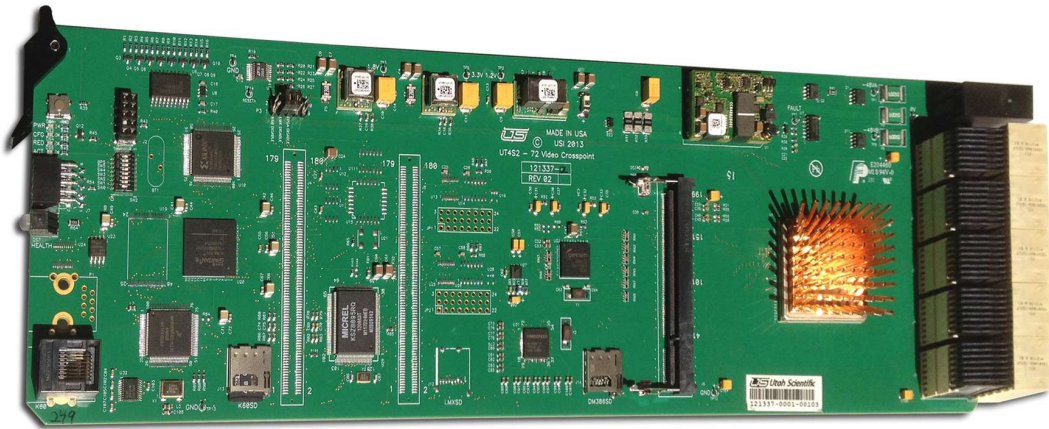

FIGURE 4-35.

The 72x72 video crosspoint provides switching for signals from 3 Mb/Sec to 3 Gb/Sec. It can be ordered in one of two ways, as a 121338-1 which has a local 144x144 crosspoint array, and as a 121338-2 that has a local 72x72 crosspoint array. Rectangular matrix loading is supported when a 121338-1 crosspoint is loaded in the system.

This crosspoint card also houses an H.264 encoding engine that creates an RTSP video stream out of the video selected by the on board monitor matrix. This stream can be monitored by a PC or by the LC3 control surface. The crosspoint supports control via MX bus or via Ethernet, and has a diagnostic port on the front edge for troubleshooting purposes.

### *Circuit Description*

The heart of the card is the 3Gb/Sec crosspoint chip, U18. It interconnects to the high speed edge connectors 144 different locations. 120 of these signal interconnects go to both an input and an output circuit on the crosspoint, allowing for the rectangular loading of the cards. This crosspoint is controlled by the FPGA U20 based on commands coming in from the MX bus or Ethernet.

Control and monitoring both of the local card and of the system (if the card is active) is accomplished by the MCU U30. It communicates to the FPGA, front panel serial port, MX bus and local compact flash card and alerts the user thru LED's or messages in RMAN in case of a failure.

The card has an integral Monitor Matrix made up of U31 (selector) and U22 (Reclocker) that provides a single copper output. In addition to this, the H.264 option can be purchased which resides in socket J6.

### *Controls And Indicators*

#### **Controls -**

Dipswitch SW2 – Reserved for factory use.

#### **Indicators –**

DS1-PWR-Green – On means the board power supplies are good.

DS2-CFG-Green – On means the onboard logic has been programmed

DS4-RED-Green – On means the board is operating in redundant mode.

DS6-ACT-Green – On means the board is operating in Active mode.

DS7-RED/GREEN – Green means no faults, red means board, power supply or reference fault.

### *Monitor Port Usage*

RJ45 connector P2 coming out the front of the board is an RS-232C based diagnostic and reprogramming port. The terminal settings, cabling and command structure are all detailed in Appendix B of this guide, titled 'The Debug Port'.

---

## *UT400 72x72 Audio Crosspoint Card – 121338-1*

### *General*

This assembly is an optional addition to the UT400 72x72 4U router frame. When it is added, it provides the router with an additional 2304x2304 TDM Audio router matrix that can be used in conjunction with any TDM audio enabled IO card, such as embedders, disembedders, MADI, or AES cards.

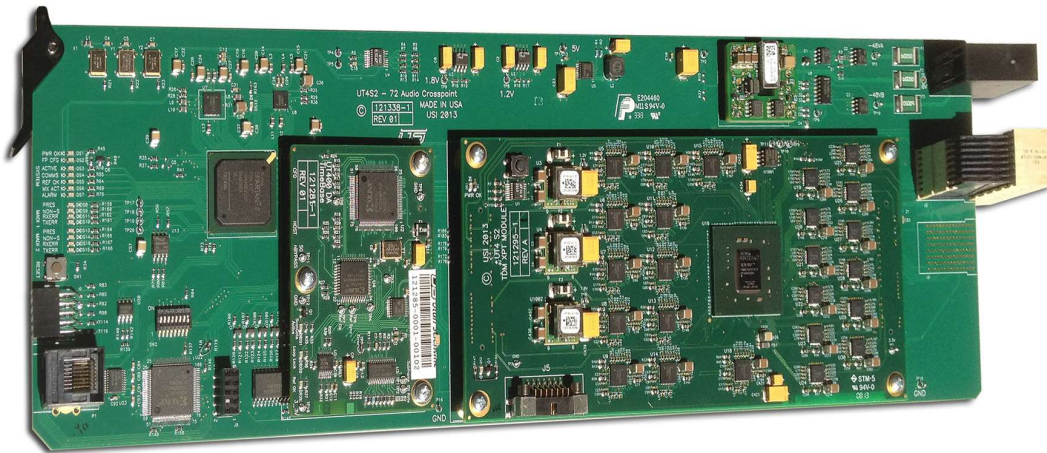

**FIGURE 4-36.**

This board also has two local MADI (64 channel) input and output ports that can either be copper or fiber based. It is important to note that this card requires two other modules to fully function. It requires an 121295-1 TDM Audio Crosspoint, and an 121285-1 Audio Timebase module.

### *Circuit Description*

Traces on the 72x72 router midplane provide this card with 18 possible TDM audio paths, each carrying 192 channels of audio. 6 are from the local IO cards, and 12 are from the input and output circuits of the IO cards in the top most slot. This allows this chassis to be a localized router or the TDM audio router for a system with remote embedder and disembedder cards.

These signals all connect to the TDM Audio crosspoint submodule. A series of resistor jumpers (R170, etc) select which of the 18 signals actually connect to submodule inputs. If the local MADI inputs are used, they connect to TDM port 7, which is input range 1536 – 1727.



FPGA U9 orchestrates the actual switching of the crosspoint submodule based on commands delivered to it via the MX Bus.

### *Controls And Indicators*

#### **Controls -**

Dipswitch SW2 –

DIP2 – On = MAD I Port 1 copper, off = MAD I port 1 fiber.

DIP3 – On = MAD I Port 2 copper, off = MAD I port 2 fiber.

#### **Indicators –**

DS1-PWR OK-Green – On = Board Power Supplies OK

DS2-FP CFG-Green – On = On board logic is programmed

DS3-Active-Green – On= Board is operating, off = board is redundant standby.

DS4-COMMS-Yellow-Flashes when communication from controller is active.

DS5-REF OK-Green – Audio reference to the frame is correct.

DS6-MX ACT-Green – Flashes when MX Bus communication is active.

DS7ALARM-RED – On indicates a problem with reference or internal comms.

DS8-11 – Status of MAD I port 1. Normal is PRES (DS8) on, all others off.

DS13-16 – Status of MAD I port 2. Normal is PRES (DS13) on, all others off.

### *Monitor Port Usage*

RJ45 connector P1 coming out the front of the board is an RS-232C based diagnostic and reprogramming port. The terminal settings, cabling and command structure are all detailed in Appendix B of this guide, titled 'The Debug Port'.

## 121332-1 SDI Module

### **General**

The SDI I/O module is a general purpose 4 in x 4 out SD/HD/3G Video processing module. It is used on various carrier cards to perform video processing functions.

### **Circuit Description**

#### **Power Supplies**

This module receives 3.3V from its carrier card on J1, and regulates it to the following voltages for use in the FPGA –

- 1.5V Via U7.
- 1.8V via U6.
- 1.2V via U1.
- 1.0V via U2.
- 1.0V 'B' supply via U4.

All of these voltages are monitored by U9, and DS6 will light if all supplies are within tolerance.

#### **FPGA**

The central component of this module is a Xilinx XC7K-160T FPGA, U3. It has support components consisting of a BPI FLASH memory for configuration (U5) and two DDR3 components for storage of video data (U8 and U10).

At power up, the FPGA will configure and if successful will light the yellow LED DS1.

#### **Video IO**

Video signals are presented to and leave the FPGA on MGT paths detailed on page 3 of the schematic.

#### **Controls**

Controls to this module are either thru dedicated pins or processor reads and writes. They are defined on the carrier cards where this module is used.

***Indicators***

DS6 – On for power supply OK.

DS1 – On for configuration done.

Note that the following definition is for UDS CQ module status only -

DS5 – Reference channel video locked when on.

DS2 – CQ Channel 1 locked when on. Video asynchronous when flickering.

DS4 – CQ Channel 2 locked when on. Video asynchronous when flickering.

DS3 – CQ Channel 3 locked when on. Video asynchronous when flickering.

---

## *UT400 Series 2 Advanced Input Card – 121395-1*

### **General**

The Advanced Input Card is a multifunction, (up to) 12 port SDI input card that installs in any UT400 Series 2 router. In addition to the standard features of Series 2 input card, this performs dis-embedding, frame sync, audio shuffling and video proc amp controls if it is purchased with the SDI I/O Processing modules. This added functionality is enabled by installing a 4 port 121332-1 SDI I/O module.

There are two versions available -

- De-embedding only
- Frame sync with de-embedding

Up to 3 of these modules can be installed on each card. For configurations where the advanced features are not needed, a 121403-1 Advanced IO Loop Thru card can be installed, making that set of 4 channels into standard input paths with no advanced features. The Advanced Input card can be purchased with two types of rear panels, a standard BNC panel 121398-1, and an advanced BNC panel 121397-1. The standard rear panel has 12 standard BNC connections and no others. The advanced rear panel has 12 connections using HD-BNC connectors, 1 TDM Audio output port, and 1 RJ-45 for Ethernet connections to the U-Control control system. This control system enables the user to adjust video and audio parameters for the signals on the card.

### Physical Description

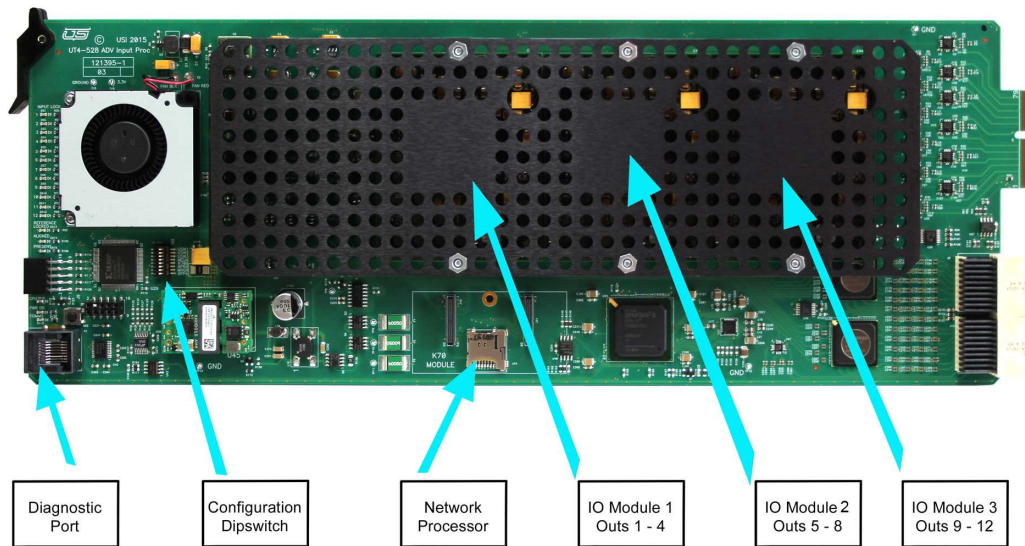

FIGURE 4-37.

The picture above details the major components of the assembly. Replacement of the individual IO modules is accomplished by removing six screws that hold the heatsink to the board from the backside, and then each module is simply pulled out of its mating connectors. Silk-screen outlines detail the orientation of the modules on the carrier board.

### Circuit Description

#### Video Path

The video signals presented to this card originate at the rear panel BNC connectors. The first component they connect to is a jitter cleaning SDI Cable Equalizer, which removes deterministic jitter from the signal before it is presented to the SDI I/O Module. The SDI I/O module will align the video signal to the local reference if the board is running in referenced mode, and apply any timing, shuffling, or video processing controls set by the U-Control software before re-embedding the audio and sending out the signal. From the output of the SDI I/O Module, the signal is driven to a fanout array that drives the signal to the four possible crosspoints in the system.

### *Audio path*

The Advanced Input Card has an onboard audio processor that receives 32 AES signals that are generated by each SDI I/O module from the dis-embedded audio signals present in the incoming video streams. These audio signals are aligned to the local audio clocks after they are dis-embedded in the case of an asynchronous input signal. The audio processor then generates a 192 channel TDM stream to be sent to the audio crosspoint in the system.

### *Control*

The 121293-1 card has an onboard microprocessor that manages housekeeping tasks such as measuring current draw and temperature, and acts as the control path for the system Frame Controller module to gather status and make changes to the card.

### *Ethernet Processor*

If equipped with the 121397-1 Advanced Rear panel, the board will have an onboard Ethernet Processor that communicates to the onboard microprocessor

### *Power Supplies*

The 121293-1 card receives -48V from the system backplane and generates 3.3V, 2.5V, 1.8V, 1.2V and 12V Supplies. All voltages are monitored for health and the failure of one of them will result in a dark 'PWR OK' LED (DS18).

## **Controls And Indicators**

### *Controls*

- SW1 Dipswitch – Used for card programming and configuration.
- Dip1 – ON Disables reference based processing, OFF Enables reference.
- Dip2 – Not currently used.
- Dip3 – Not currently used.
- Dip4 – ON removes CPU from Scangate chain, OFF includes
- Dip5 – ON removes Network Processor from Scangate chain, OFF includes
- Dip6 – ON removes Audio Processor from Scangate chain, OFF includes
- Dip7 – ON removes SDI I/O modules from Scangate chain, OFF includes
- Dip8 – ON places Scangate chain in Bypass mode, OFF is normal operation.
- Normal configuration is all OFF.

SW2 Reset switch - Pressing this switch performs a cold reset of the board.

*Indicators*

DS1-DS12 – Green – Input Locked - Video channels 1-12 respectively. ON indicates that the video circuit has locked to the incoming video.

DS19 – Green - ON indicates that the audio processor circuit is configured.

DS17 – Green –POWER GOOD - ON indicates that all supplies are healthy.

DS18 – Yellow – Comms - ON indicates that the card is being addressed by the router control system.

DS16 – Green – ON indicates that the CPU is configured and running.

DS13, 14 and 15 – Green – Reference locked indicators. In referenced operation, all of these LED's should be on. In non-referenced operation, they are not meaningful. .

## Operational Modes

### *With Loop thru modules –*

No special features are available.

### *With Frame Sync Firmware running in SDI IO modules –*

The Frame Sync mode, when reference is applied to the card, will take asynchronous sources and align them to the local reference before sending them out of the card. This is accomplished by repeating or dropping video frames when necessary, and repeating or dropping Audio samples when necessary. The timing of the video signal when it leaves the card has + or – 1 Frame of adjustment to the pixel level.

The reference mechanism is required in order to re-align the incoming video signals. Reference mode is only enabled if Dip1 of SW1 is OFF and a reference signal is applied to the routing switcher Ref A port. This reference signal must be the same time base (50 or 59.94 Hz) as the video signals in the router, and should be Black Burst.

If the reference is not present or is disabled, the inputs are still processed and dis-embedded, but no realignment is performed.

## Serial Diagnostic Port Commands

This serial port is primarily used by Utah Scientific Service personnel to determine the state of the card during troubleshooting.

This port is RS-232, 115.2KBaud, 8 data bits, 1 stop bit and no parity.

The pinout is based on the 140000-9 UT400 diagnostic adapter provided with every UT400 system.

The port displays a menu when sent a space or carriage return character. The menu is –

```
-----  
S - STATUS  
B - Reprog Menu  
P - Read LMH1983 Regs  
D - Dump I2C Regs  
V - Versions  
-----
```



Each menu element is invoked by pressing the letter indicated by the menu. **Specifications**

Power Consumption

30 Watts

Input Return Loss

Less than -15 dB to 1.5 Ghz, Less than -10 dB to 3 Ghz.

Input Amplitude

800mV +- 10%

Supported Video Formats

SMPTE259C – 525 Line and 625 Line

SMPTE292 – 1080i 50/60 Hz, 720P 50/60 Hz

SMPTE424 – 1080P 50/60 Hz, Level A only. There is no support for Level B.

## **Specifications**

*Power Consumption*

30 Watts

*Input Return Loss*

Less than -15 dB to 1.5 Ghz, Less than -10 dB to 3 Ghz.

*Input Amplitude*

800mV +- 10%

*Supported Video Formats*

SMPTE259C – 525 Line and 625 Line

SMPTE292 – 1080i 50/60 Hz, 720P 50/60 Hz

SMPTE424 – 1080P 50/60 Hz, Level A only. There is no support for Level B.

---

## *UT400 Series 2 Advanced Output Card – 121396-1*

### **General**

The Advanced Output Card is a multifunction, (up to) 12 port SDI card that installs in any UT400 Series 2 router. In addition to the standard features of Series 2 output card, this card can be purchased in two versions; enabling embedding and/or Clean/Quiet switching or embedding only of the outputs in groups of 4 channels.

There are two versions available -

- Clean/Quiet with embedding provides (12) outputs with (3) sub-modules.
- Embedding *only* providing (12) outputs with (3) sub-modules.

*(There is no Clean/Quiet only version)*

This added functionality is enabled by installing a 4 port 121332-1 SDI I/O module. Up to 2 SDI modules can be installed on each card. For configurations where the advanced features are not needed, a 121403-1 Advanced IO Loop Thru card can be installed, making that set of 4 channels into standard output paths with no advanced features.

The Advanced Output card can be purchased with two types of rear panels, a standard BNC panel 121398-1, and an advanced BNC panel 121397-1. The standard rear panel has 12 standard BNC connections and no others. The advanced rear panel has 12 connections using HD-BNC connectors, 1 TDM Audio input port, and 1 RJ-45 for Ethernet connections to the U-Control control system. This control system enables the user to adjust video and audio parameters for the signals on the card.

## Physical Description

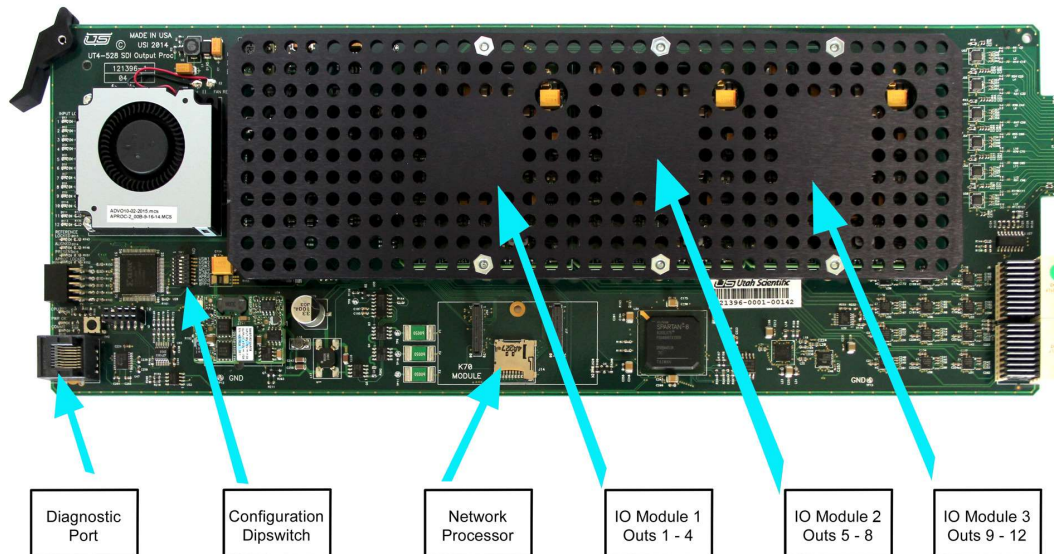

FIGURE 4-38.

The picture above details the major components of the assembly. Replacement of the individual IO modules is accomplished by removing six screws that hold the heatsink to the board from the backside, and then each module is simply pulled out of its mating connectors. Silk-screen outlines detail the orientation of the modules on the carrier board.

## Circuit Description

### Video Path

The video signals presented to this card originate at the video crosspoint card in the system. Each video channel has two possible paths, from either the primary or the redundant crosspoint card. The signals arrive as a differential pair from the crosspoint.

The first component they connect to is a reclocker, which removes deterministic jitter from the signal before it is presented to the SDI I/O Module. From the output of the SDI I/O Module, the signals driven to a cable driver component near the gold fingers at the rear edge of the card which sends the signals to the BNC rear panel.

### **Audio path**

The Advanced Output Card has an onboard audio processor that receives a TDM stream containing up to 192 channels of audio and timing information from the system audio crosspoint. These signals are turned into 96 AES pairs, 32 of which are presented to each SDI I/O Module.

### **Control**

The 121396-1 card has an onboard microprocessor that manages housekeeping tasks such as measuring current draw and temperature, and acts as the control path for the system Frame Controller module to gather status and make changes to the card.

### **Ethernet Processor**

If equipped with the 121397-1 Advanced Rear panel, the board will have an onboard Ethernet Processor that communicates to the onboard microprocessor

### **Power Supplies**

The 121396-1 card receives -48V from the system backplane and generates 3.3V, 2.5V, 1.8V, 1.2V and 12V Supplies. All voltages are monitored for health and the failure of one of them will result in a dark 'PWR OK' LED (DS18).

### **Controls And Indicators**

#### **Controls**

- SW1 Dipswitch – Used for card programming and configuration.
- Dip1 – ON Disables reference based processing, OFF Enables reference.
- Dip2 – Not currently used.
- Dip3 – ON sets board usage in an XL router, OFF in any other router type.
- Dip5 – ON removes Network Processor from Scangate chain, OFF includes
- Dip6 – ON removes Audio Processor from Scangate chain, OFF includes
- Dip7 – ON removes SDI I/O modules from Scangate chain, OFF includes

- Dip8 – ON places Scangate chain in Bypass mode, OFF is normal operation.
- Normal configuration is DIP1 ON, all others OFF.

SW2 Reset switch - Pressing this switch performs a cold reset of the board.

### **Indicators**

DS1-DS12 – Green – Output Locked - Video channels 1-12 respectively. ON indicates that the video circuit has locked to the incoming video.

DS20 – Green - ON indicates that the audio processor circuit is configured.

DS18 – Green –POWER GOOD - ON indicates that all supplies are healthy.

DS19 – Yellow – Comms - ON indicates that the card is being addressed by the router control system.

DS17 – Green – ON indicates that the CPU is configured and running.

DS16 – Green – Indicates that the audio processor has acquired the TDM signal from the Audio crosspoint card.

DS13, 14 and 15 – Green – Reference locked indicators. In referenced operation, all of these LED's should be on. In non-referenced operation, they are not meaningful.

### ***Operational Modes***

#### **With Loop thru modules –**

No special features are available.

#### **With Embedder Only Firmware –**

The enabled modules will perform embedding functionality when commanded by the SC-4 control system. No user intervention other than routing commands is required.

#### **With Clean/Quiet Firmware –**

The clean/quiet outputs perform special processing on the video signal when they detect a switch in the crosspoint core of the router. The switch is detected by means of CRC errors in the video signal, which are induced when a router switch occurs. When a switch is detected, the output will-

- Hold the current video frame.

- Fade the embedded audio signals within it down to a mute level over a 1024 sample period.
- Wait until the next video frame is acquired.
- Begin outputting that new video signal.
- Fade the audio signals up to unity gain.

The module must buffer a full frame of video to allow for this processing, so the outputs have an inherent 1 frame of delay built in to them.

### **Referenced/Non Referenced Operation**

The reference mechanism is used for an additional function of the clean/quiet outputs, the ability to re-align the clean/quiet outputs to a common timebase. Reference mode is only enabled if Dip1 of SW1 is OFF and a reference signal is applied to the routing switcher Ref A port. This reference signal must be the same time base (50 or 59.94 Hz) as the video signals in the router, and should be Black Burst.

Referenced operation. When the module detects this reference signal, it will align the clean/quiet output signals to this reference, resulting in an output that both switches cleanly and is automatically timed to house, regardless of the timing of the input signal.

Non-Referenced operation. In this mode, the outputs still perform clean/quiet switching, but the timing of their output signals is based on the timing of the input signal.

Audio embedding based on router switching commands is an additional feature of the Clean/ Quiet firmware.

The Clean/Quiet Firmware also enables the use of the U-Control software package that gives access to all of the video control and audio shuffling features of the board.

### Serial Diagnostic Port Commands

This serial port is primarily used by Utah Scientific Service personnel to determine the state of the card during troubleshooting.

This port is RS-232, 115.2KBaud, 8 data bits, 1 stop bit and no parity.

The pinout is based on the 140000-9 UT400 diagnostic adapter provided with every UT400 system.

The port displays a menu when sent a space or carriage return character. The menu is –

```
-----  
S-STATUS  
P-LMH1983 Read  
O-LMH1983 write  
R-Read Memory  
W-Write Memory  
I-Inc AES Monitor  
T-Toggle in mux  
G-Read Scangate  
L-Toggle SPI Storage Prom Access - K70 or Local  
X-Perform SPI Device ID  
Y-SPI Regs FCO-FD8  
-----
```

Each menu element is invoked by pressing the letter indicated by the menu.

### **Specifications**

Power Consumption

30 Watts

Output Return Loss

Less than -15 dB to 1.5 Ghz, Less than -10 dB to 3 Ghz.

Output Amplitude

800mV +- 10%

Supported Video Formats

SMPTE259C – 525 Line and 625 Line

SMPTE292 – 1080i 50/60 Hz, 720P 50/60 Hz

SMPTE424 – 1080P 50/60 Hz, Level A only. There is no support for Level B.

### **Power Supplies**

The system contains two internal power supplies with three LED's each. A green Power OK LED and two red alarm LED's, one for DC voltage and one for temperature. The power supplies contain integral fans that will continue to run from the voltage supplied by the other power supply in case of a failure.



---

*UT400 Series 2 MOHO Video + MADI Output Card*

---

**General**

The MOHO Video + MADI output card is used in any UT400 Series 2 router as an output device to generate 12 video signals and three MADI signals from the video and TDM audio crosspoint cores. It occupies a single slot and utilizes HD-BNC connectors to allow for the 15 rear panel connections it requires.

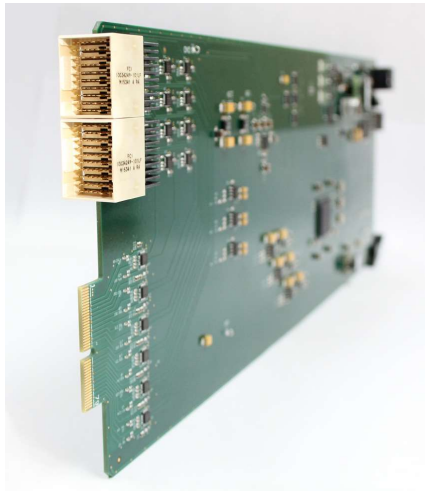
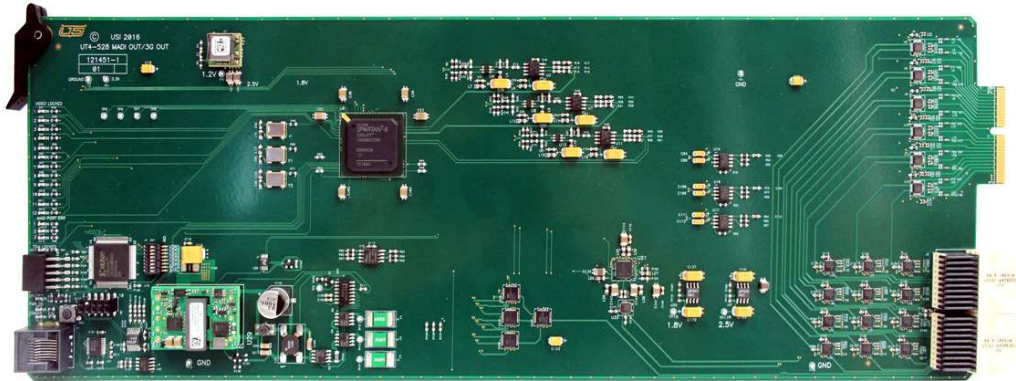

**FIGURE 4-39.**

## **Circuit Description**

### *Power Supplies*

The board receives two -48V feeds from the router power distribution system and utilizes the one that provides more voltage. From this -48V rail a 3.3V supply (u29) 1.2V supply (U1) 2.5V supply (U27) and 1.8V supply (U26). These voltages are required by the various components on the board. All of the power supplies are monitored by U39 and a overall Power Good is generated which drives LED DS18 if true.

### *Video Circuitry*

Video signals from the crosspoint core are received by the 12 M31245 Reclocker IC's. These components have signal equalizers and reclockers that remove jitter from the signals coming from the Video Crosspoint core. These parts are directed to look at either the primary or redundant feed by the control system. When the reclocker has acquired the video signal the onboard controller will illuminate a LOCK LED for that particular channel on the board front edge.

If the signal is not a SMPTE 259, 292 or 424 compliant viodeo signal, (such as an ASI signal) the reclocker will bypass its reclocking stage and still pass the signal. The lock LED will not illuminate in this case. From the reclockers, the signal is fed into one of the 6 M21528 dual cable driver components on the card. The signal is amplified and sent out of the rear panel as a SMPTE compliant waveform.

### *MADI Circuitry*

The audio signals contained in the three MADI outputs originate at the TDM audio crosspoint card. This signal that contains 192 channels of audio is received by U33, which is commanded to select either the primary or redundant crosspoint by the router control system. From U33, the signal is sent to U21, a de-serializer component that breaks the TDM signal into its unique audio channels and presents them to component U9, an FPGA. The FPGA receives, aligns, and packages the 192 audio signals into 3 groups of 64. These three groups are formatted into 64 channel MADI streams and sent to U14, U16 and U17 who generate the 600mV, 75 ohm coaxial MADI output that is presented to the rear panel BNC's.

### *System Control*

FPGA component U9, in addition to containing the MADI circuitry, also has a soft core processor that performs several functions.

#### Additional Functions

- Monitors board level power consumption and temperature and relates that to the Router Control System.
- Responds to commands received from the router control system to select primary and redundant crosspoints, change monitor matrix selection, enable and disable outputs, and others.
- Provides a user interface via the P1 serial port to diagnose board operation.

### Controls And Indicators

#### *Controls*

SW1 Dipswitch – Used to set various diagnostic functions, and to set whether or not the system resides in an XL router or any other router type.

DIP3 – ON for XL router, OFF for any other type.

ALL Other switches – OFF for normal operation.

SW2 Reset switch - Pressing this switch performs a cold reset of the board.

#### *Indicators*

DS13- DS15 – RED - MADI TX Channel error indicators. These LED's indicate if there are any errors in the outgoing MADI streams. An on state indicates that the status is active.

DS1 - DS12 – GREEN – On indicates that the Video Reclocker for that channel has locked to a SMPTE compliant signal.

DS16 – TDM LOCK – Indicates that the card has locked to the TDM stream coming from the crosspoint card (input) or is generating that stream (output).

DS17 – FPGA CONFIG – Indicates that the on board FPGA is configured.

DS19 – Yellow – Indicates that the card is being accessed by the chassis control system.

DS18 – Green – Indicates that the board power system is OK.

## **Specifications**

### *Power Consumption*

8 Watts (.12A of -48V)

### ***MADI***

Conforms to AES-10-2008

Return Loss - Less than -15 dB to 125MHz.

Output Amplitude – 600mV

### ***Video***

Confirms to SMPTE 259, 292 and 424 standards

Return Loss – Less than -15 dB to 1.5GHz, less than -10 dB to 3 GHz.

Output Amplitude - 800mV +- 10%.

## Rear Panel Connections

This card uses the 121452-1 16 HD-BNC Rear Panel. MADI and video ports are labeled on this rear panel. The TDM port is not used on this assembly.

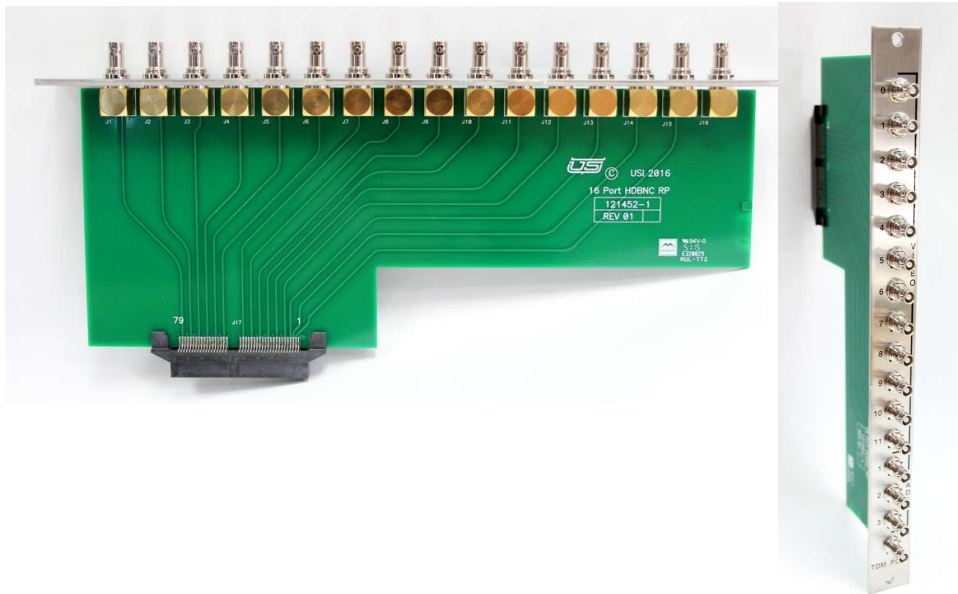

FIGURE 4-40.

---

## Serial Diagnostic Port Commands

This diagnostic port utilizes the 140000-9 UT400 serial adapter. The adapter should be placed on the DB9 RS-232 connector of a standard computer, and then a length of straight thru CAT5 cable connected between the other end of the adapter and P1 on the board.

Terminal emulators such as TeraTerm are used to communicate with the board. The terminal emulation settings should be –

- Baud – 115.2K Baud
- Stop Bits – 1
- Data Bits – 8
- No Parity
- Handshake – Xon/Xoff



---

## *UT400 Series 2 MIHI Video + MADI Input Card*

---

### **General**

The MIHI Video + MADI input card is used in any UT400 Series 2 router as an input device to receive 12 video signals and three MADI signals and present them to the video and TDM audio crosspoint cores. It occupies a single slot and utilizes HD-BNC connectors to allow for the 15 rear panel connections it requires.

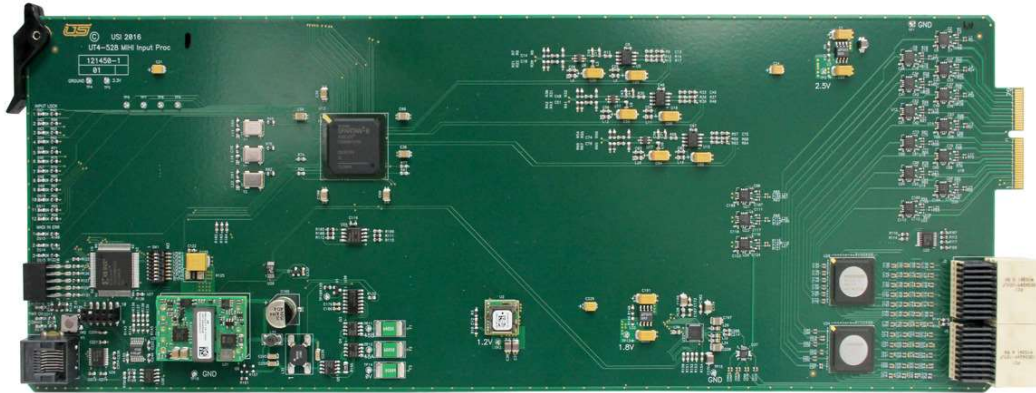

FIGURE 4-41.

---

### **Circuit Description**

#### *Power Supplies*

The board receives two -48V feeds from the router power distribution system and utilizes the one that provides more voltage. From this -48V rail a 3.3V supply (u31) 1.2V supply (U2) 2.5V supply (U3) and 1.8V supply (U32). These voltages are required by the various components on the board. All of the power supplies are monitored by U35 and an overall Power Good is generated which drives LED DS17 if true.

#### *Video Circuitry*

Video signals from the edge connector are received by 12 M21564 Equalizing Receivers. These receivers are capable of receiving 150 meters of 3G SDI signals, 200 meters of HD-SDI and 250 meters of SD-SDI signals. Internal registers in these parts indicate whether or not they have acquired a signal, causing the appropriate Signal Presence LED on the board front

edge to light. From the output of the cable equalizers, the signals go to one of two 6x24 crosspoint chips, U234 and U28, which are used to drive four copies of each signal to the crosspoint cards in the router.

### *MADI Circuitry*

Three MADI inputs are presented to this card and received by three M21564 equalizing receivers. The signals are then presented to FPGA U13. In U13 the MADI streams are decoded and the 64 channels of audio from each MADI stream are combined into a 192 channel TDM stream that is delivered to the TDM crosspoint matrix in the system by transmitter components U33 and U37. A monitor, which presents the 192 channels of audio 2 channels at a time, is available at diagnostic port P1 and is controlled by the terminal interface.

### *System Control*

FPGA component U13, in addition to containing the MADI circuitry, also has a soft core processor that performs several functions.

It monitors board level power consumption and temperature and relates that to the Router Control System.

It responds to commands received from the router control.

It provides a user interface via the P1 serial port to diagnose board operation.

## **Controls And Indicators**

### *Controls*

SW1 Dipswitch – Used to set various diagnostic functions. This switch should be set to ALL OFF for normal operation.

SW2 Reset switch - Pressing this switch performs a cold reset of the board.

### *Indicators*

DS13- DS15 – RED - MADI RX Channel error indicators. These LED's indicate if there are any errors in the incoming MADI streams, including absence of the signal. An on state indicates that the errors are present, a dark LED indicates normal MADI reception.

DS1 - DS12 – GREEN – On indicates that the Video Equalizer for that channel has locked to a SMPTE compliant signal.

DS16 – FPGA CONFIG – Indicates that the on board FPGA is configured.

DS18 – Yellow – Indicates that the card is being accessed by the chassis control system.

DS17 – Green – Indicates that the board power system is OK.



## Specifications

### *Power Consumption*

8 Watts (.12A of -48V)

### *MADI*

Conforms to AES-10-2008 Return Loss - Less than -15 dB to 125MHz.

### *Video*

Confirms to SMPTE 259, 292 and 424 standards Return Loss – Less than -15 dB to 1.5GHz, less than -10 dB to 3 GHz.

## Rear Panel Connections

This card uses the 121452-1 16 HD-BNC Rear Panel. MADI and video ports are labeled on this rear panel. The TDM port is not used on this assembly.

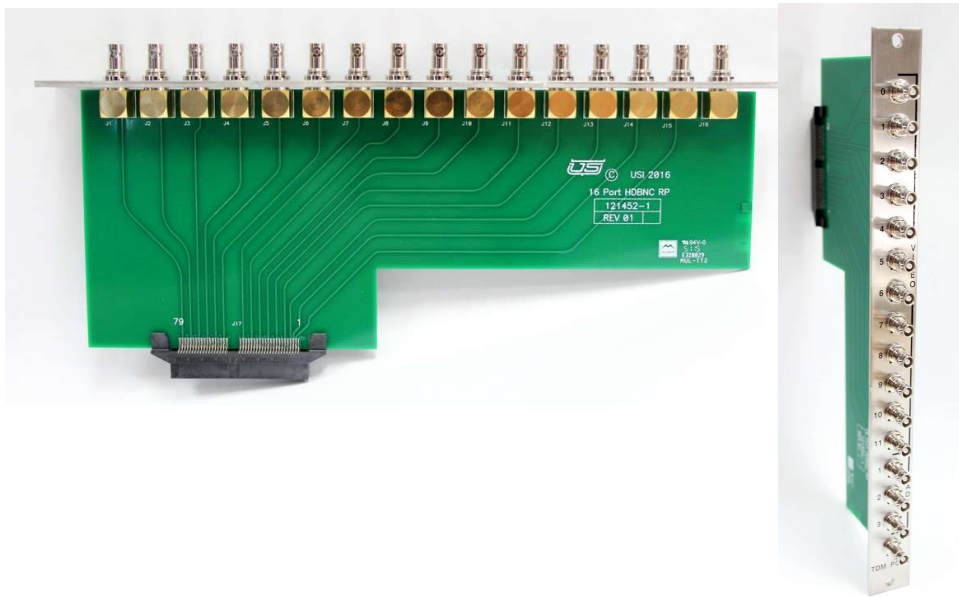

FIGURE 4-42.

### Serial Diagnostic Port Commands

This diagnostic port utilizes the 140000-9 UT400 serial adapter. The adapter should be placed on the DB9 RS-232 connector of a standard computer, and then a length of straight thru CAT5 cable connected between the other end of the adapter and P1 on the board.

Terminal emulators such as TeraTerm are used to communicate with the board. The terminal emulation settings should be –

- Baud – 115.2K Baud
- Stop Bits – 1
- Data Bits – 8
- No Parity
- Handshake – Xon/Xoff

Below is the menu structure reported when the user presses the space bar. To invoke a menu item the first letter of that item is pressed.

```
-----  
S-STATUS  
R-Read Memory  
I-Inc AES Monitor  
V-Versions  
-----  
Status – Displays various operating parameters of the card –  
>s  
Part =1450, Serial =064, USerSW=0, Sub=0001, Rev=3031  
VSignl Presence = 0800  
AMonitor Select = 0  
Current = 6 W, Temp = 45C, FB1 Temp = 89, FB2 Temp = 88  
EQ Status -  
RGC=08 JCL=01.  
RGC=08 JCL=01.  
RGC=08 JCL=01.  
RGC=08 JCL=01.  
RGC=08 JCL=01.  
RGC=08 JCL=01.  
RGC=08 JCL=01.  
RGC=08 JCL=01.  
RGC=08 JCL=01.  
RGC=08 JCL=01.
```

RGC=08 JCL=01.

RGC=08 JCL=01.

RGC=88 JCL=81.

RGC=08 JCL=01.

RGC=08 JCL=01.

RGC=88 JCL=01.

MADI Registers -

Ch1 - VCO\_C = 0080 VCO\_D = 05, Stat reg = 03, Err Reg = 90.

Ch2 - VCO\_C = 0080 VCO\_D = 05, Stat reg = 03, Err Reg = 90.

Ch3 - VCO\_C = 0080 VCO\_D = 05, Stat reg = C3, Err Reg = 01.

Version – Displays SW and FW versions on the card.

>v

\*\*\*\*\*

\* 1450-1 MIHI 1-31-16 \*

\*SW V01.03 FW V01.05 \*

\*\*\*\*\*

---

## *UT400 Series 2 SMPTE 2022 Receiver (121400-1)*

### **General**

This Series 2 router input module, USI PN 121400-1, is a device that is used to de-packetize SMPTE 2022-5/6 compliant Ethernet signals into SDI video. It contains two identical circuits that each receive a 10GBASE-X Ethernet link and convert them into SDI signals.

Each circuit has the capability of processing 6 channels of SDI video when all of their standards are either SD-SDI or HD-SDI. When one or more of the signals are 3G-SDI, the number of SDI channels supported reduces to 3 in order to stay below the 10Gb/Sec capacity of the Ethernet link.

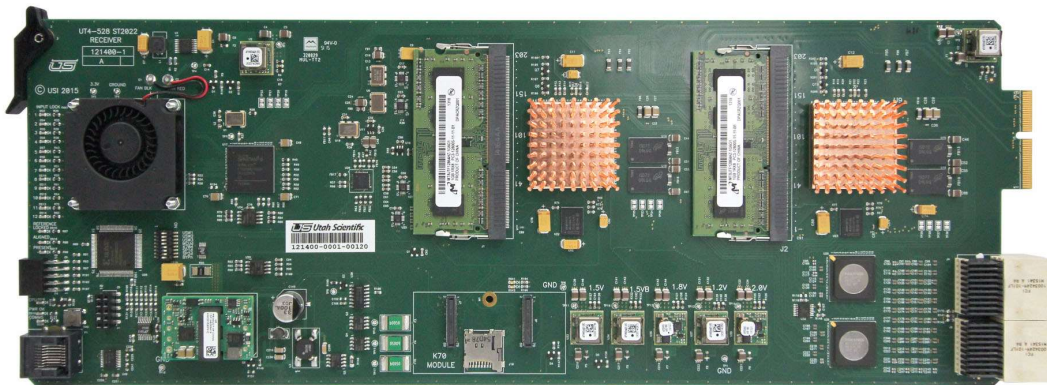

**FIGURE 4-43.**

---

### **Circuit Description**

#### *Power Supplies*

This assembly receives two -48V feeds from the router slot it is inserted into. The hot swap circuit made of U30 and its associated components determines which feed is more appropriate to use and supplies a filtered -48V feed to the main 3.3V regulator U41. All other board level power supplies are derived from this 3.3V rail.

The other supplies on the board are –

- 1.0VA – U2 – 2022 Proc A core
- 1.0VB – U3 – 2022 Proc B core
- 1.5VA – U33 – 2022 Proc A DDR
- 1.5VB – U34 – 2022 Proc B DDR
- 1.8V – U36 – 2022 Proc Aux voltage
- 2.0V – U35 – 2022 Aux IO voltage
- 1.2V – U34 – Fanout Buffer supply
- 5V – U1 – Fan Voltage

All of these power supplies are monitored by U38 and an overall board reset is generated based on their levels. DS19, the Power Good LED, illuminates when all supplies are in tolerance.

### *Control Processor*

U17 is a Xilinx XC6SLX25 FPGA with a softcore processor. It manages board level health and communications including power used, temperature, communications with the router FCM and internal SPI control bus fanout. It includes an RS232 interface at P1 that allows for board level diagnostics.

### *Clocks and Reference*

U20 is a genlock part that receives an analog reference signal from the router core and provides all of the clocks necessary for the board to operate. It will automatically free-run when configured to or upon the loss of the reference signal.

### *Network Processor Module*

The socket made up of J7 and J8 houses an optional network processor module that communicates with the UControl PC application. This processor monitors and controls all of the setting for reception of SMPTE 2022 signals by the two 10GE processors on the card. The board will operate without this module, but control settings are manually changed via an RS-232 connection to P1.

### *SMPTE 2022 processor #1.*

U8 and its associated components make up the first SMPTE 2022 receiver, which receives one 10G Ethernet stream and converts it into up to 6 SDI channels, depending upon its configuration. The SDI signals are delivered to the Fanout Buffer components to be sent to downstream crosspoint cards in the matrix.

### *SMPTE 2022 processor #2.*

U9 and its associated components make up the second SMPTE 2022 receiver.

### *Fanout Components*

U28 and U39 are 8x24 crosspoints that are used as 6 1x4 fanout buffers for the 12 video signals leaving this card. A unique copy of each input signal is sent to each of the four possible crosspoint cards this card needs to support.

### **Controls and Indicators**

SW1 Dipswitch – Used for card programming and configuration.

- Dip1 – ON Disables reference based processing, OFF Enables reference.
- Dip2 – Not currently used.
- Dip3 – Not currently used.
- Dip4 – ON removes CPU from Scangate chain, OFF includes
- Dip5 – ON removes Network Processor from Scangate chain, OFF includes
- Dip6 – ON removes S2022 #1 from Scangate chain, OFF includes
- Dip7 – ON removes S2022 #2 from Scangate chain, OFF includes
- Dip8 – ON places Scangate chain in Bypass mode, OFF is normal operation.
- Normal configuration is DIP1 ON, all others OFF.

SW2 Reset switch - Pressing this switch performs a cold reset of the board.

### *Indicators*

DS1 – Green – S2022 Processor #1 configured.

DS2 – Green – S2022 Processor #2 configured.

DS3-DS14 – Green – Input Locked - Video channels 1-12 respectively. ON indicates that the video circuit has locked to the incoming video.

DS15, 16 and 17 – Green – Reference locked indicators. In referenced operation, all of these

DS18 – Green – ON indicates that the CPU is configured and running.

DS19 – Green –POWER GOOD - ON indicates that all supplies are healthy.

DS20 – Yellow – Comms - ON indicates that the card is being addressed by the router control system.

LED's should be on. In non-referenced operation, they are not meaningful.

P1 is a quad purpose port that is used for standard UT400 diagnostic functions, Ethernet Control Circuit and SMPTE 2022 transmit configuration for both channels. The terminal interface section of this guide contains more information on using diagnostic/configuration port.

### Rear Panel Connections

This card can install into any output slot in a Series 2 router. The rear panel of that slot must be replaced with USI PN 121402-1, SMPTE 2022IO adapter. This adapter has six connections –

1. 100Mbit MGMT ENET LAN connection, via an RJ45. Connect to an Ethernet network using a CAT5 cable. This port is used by USI software applications to manage and control the functions of the card.
2. 10G – 1PRI and 1SEC. Primary/Secondary SFP+ ports for the first SMPTE 2022 channel. This can be fitted with an 10GbE SFP or an SFP Direct Attach cable for connection to an Ethernet switch.
3. 10G – 2PRI and 2SEC – Primary/Secondary SFP+ ports for the second SMPTE 2022 channel. This can be fitted with an 10GbE SFP or an SFP Direct Attach cable for connection to an Ethernet switch.
4. Monitor Port. This can optionally be fitted with a FlexIO SFP to SDI module for SDI monitoring of the signals being packetized on each Ethernet port.

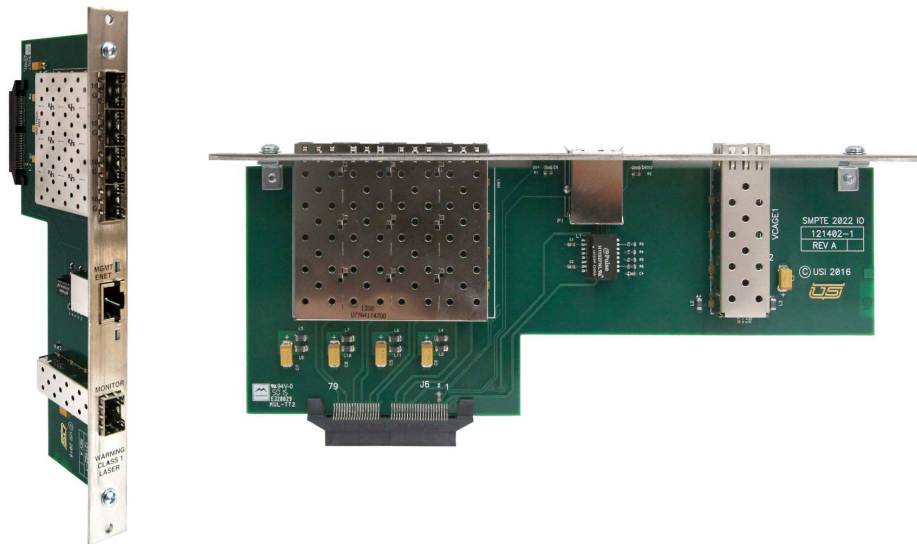

FIGURE 4-44.

## **Terminal Interface**

The P1 serial port is an RS-232 port used to diagnose or configure the card. There are four active devices on the board that communicate out of this port. The user switches between devices by issuing special keyboard commands.

P1 is designed to connect via a straight thru CAT5 or 6 cable to the standard UT400 serial adapter, 140000-8, and then to an RS-232 port on a PC.

A terminal emulation program such as TeraTerm is used to communicate to the board.

The serial port operates at 115.2KBaud, 8 data bits, 1 stop bit and no parity.

The four devices connected to this port are -

- Local monitoring processor. Used to determine overall board state.
- K70 Network Control Layer Processor. Console for Linux network manager.
- 2022 Port #1 Processor. Console for SMPTE stream corresponding to SDI ports 0-5.
- 2022 Port #2 Processor. Console for SMPTE stream corresponding to SDI ports 6-11.

To switch between the 4 devices, hold down the CTRL key and press 'p'. Upon each press of this key combination the terminal will report the device connected to the serial port -

"UBlaze Debug" for the local monitoring processor.

"K70 Debug" for the network control layer processor.

"2022 #1 Debug" for the first 2022 processor.

"2022 #2 Debug" for the second 2022 processor.

The terminal commands available for each port are listed below.

Upon power up, the boards local monitoring processor is connected to the serial port.



## Local Monitoring Processor Menu

-----  
S-STATUS  
R-Read Memory  
P-Genlock Read  
D-Dump I2C Regs  
G-Read Scangate  
-----

These menu items are used with support from USI service personnel to diagnose performance of the card.

### *K70 Network Processor Menu –*

This interface is a Linux console that displays or controls functions of the network processor. These menu items are used with support from USI service personnel to diagnose performance of the card.

### *SMPTE 2022 Processor Menu –*

This menu structure is the same for both instances of the SMPTE 2022 receiver on the card. There are two main sections to this menu; the first to configure items common to all streams, and a channel specific menu to configure items that are specific to each video stream. A '?' displays the selections in all menus.

### *Main Menu*

-----  
-- VoIP RX Main Menu --  
-- Jan 6, 2016  
-----

### *Select option*

1 = Reset Core  
2 = Initialize Core

3 = 10G MAC Fault Inhibit On/Off  
7 = USI Menu  
r = Reset General Space Stat Counters  
s = Configure Channel  
p = Probe Current Settings  
? = help

-----

*Main Menu Descriptions*

1 – Reset Core. Resets all processing functions.  
2 – Initializes each channel with default values (Note that after a reset, an initialization must be performed.  
3 – 10G MAC Fault inhibit on/off  
7 – USI Specific diagnostic functions.  
S – Go to channel specific menu

*Select Channel Menu*

-----

-- Select Channel --

-----

Primary Channels

1 = Channel 1  
2 = Channel 2  
3 = Channel 3  
4 = Channel 4  
5 = Channel 5  
6 = Channel 6

-----

>

Select 1-6 to select the channel number to be configured or monitored.

Channel Specific Menu

-----  
-- Select Option --  
-----

- 1 = Channel Init
- 2 = Channel Enable/Disable
- 3 = Match VLAN On/Off
- 4 = Timestamp Bypass On/Off
- 5 = Channel Filter Change
- 6 = Dest IP Addr
- 7 = Host IP Addr
- 8 = Dest Port
- 9 = Source Port
- a = SSRC
- p = Probe Status
- q = Probe Statistic
- r = Channel Statistics Reset
- m = Main Menu
- s = Channel Select

- 
- 1 = Channel Init – Re-initializes settings in the currently selected channel.
  - 2 = Channel Enable/Disable – Enables or disables the current channel (toggle)
  - 3 = Match VLAN – Determines if the VLAN tag is part of the packet filter for this channel.
  - 4 = Timestamp Bypass – Bypass or include Timestamp information for this channel.
  - 5 = Channel filter change – Include or exclude various parameters in the packet filter for this channel.

6 = Change Dest IP Addr – Sets the destination IP Address for this channel filter.

7 = Change SRC IP Addr – Sets the source IP Address for this channel filter.

8 = Set Dest UDP Port – Sets the destination UDP for this channel filter.

9 = Set Source UDP Port – Sets the source UDP port for this channel filter.

a = Set SSRC – Sets the SSRC value for this channel filter.

p = Probe Status – Displays status of this channel

q = Probe Statistic – Shows packet counters for this channel.

r = Receive Packet Count Stat Reset – Resets counters for this channel.

p = Probe Status – Displays status of this channel

m = Main Menu – Return to Main Menu

s = Channel Select – Return to Channel Select Menu.

*Typical Channel Status report –*

Channel 1 Status:

Channel Enable : Channel Enable

Primary Stream Status

Type of Service: 100

Time to Live: 128

Primary Stream Filter Setting

Dest IP Addr: 192.168.5.10

Host IP Addr: 192.168.5.11

Dest Port: 0x2710

Source Port: 0x2710

SSRC: 0x12345600

Current Filter Setting for PRIMARY link for channel 1

Match Select:

SSRC: Off

Dest UDP: On

Source UDP: On

Dest IP: Off

Src IP: Off  
VLAN: Off

Vid Locked: Locked  
SDI Frame Synced: Synced  
Vid Source Format: 0x2017100  
Hitless Protection: Not Protected  
RTP TS Difference: 21075 ms  
FEC Size: 00x00  
FEC Locked: 0  
FEC Level: A

### ***Specifications***

Power Consumption  
30 Watts

#### *SDI Video*

Supported Video Formats

SMPTE259C – 525 Line and 625 Line

SMPTE292 – 1080i 50/60 Hz, 720P 50/60 Hz

SMPTE424 – 1080P 50/60 Hz, Level A only.

#### *10G Ethernet*

The 10G Ethernet Ports on this card support SFF-8431 compliant SFP+ modules or SFP-DA cables not exceeding 2 meters in length.

## *UT400 Series 2 SMPTE 2022 Transmitter (121401-1)*

### General

This Series 2 router output module, USI PN 121401-1, is a device that is used to packetize SDI video into SMPTE 2022-5/6 compliant Ethernet signals. It contains two identical circuits that each receive 6 SDI signals and multiplex them into a 10GBASE-X SFP+ based Ethernet link.

Each circuit has the capability of processing 6 channels of SDI video when all of their standards are either SD-SDI or HD-SDI. When one or more of the signals are 3G-SDI, the number of SDI channels supported reduces to 3 in order to stay below the 10Gb/Sec capacity of the Ethernet link.

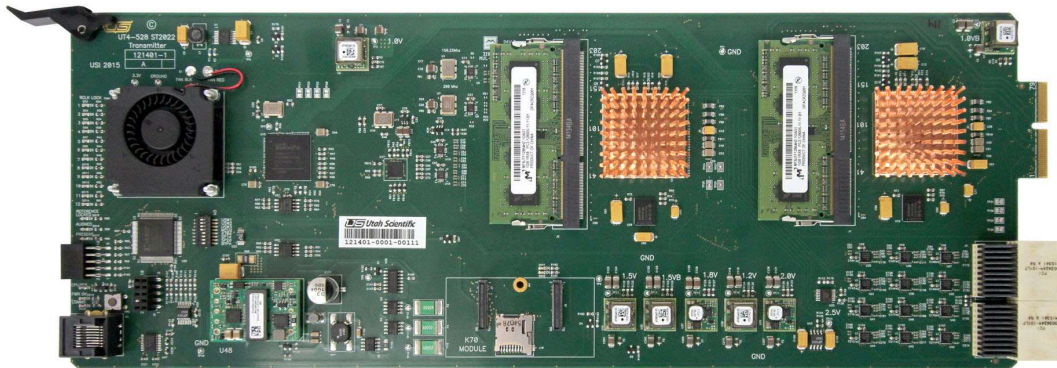

FIGURE 4-45.

### Circuit Description

Signals enter this card from multiple crosspoint cards. The control signals from the Frame Communication module determine whether the output stage selects signals from the Primary or Redundant Crosspoint cards.

Once an input is selected, the output stage reclocks it to remove excessive jitter, and then presents it to a Xilinx XC7K325T FPGA for processing.

The Xilinx FPGA receives the SDI signals, converts them into SMPTE compliant data packets, and then transmits them over the Ethernet link with the properties defined in the configuration of the card.

The terminal interface section below details the default parameters of the card, and how the parameters can be changed to customize the output to particular network requirements. A Genlock circuit on the card receives reference signals from the Frame Controller module within the frame and uses those signals to create clocks that are aligned to a house reference. The board can operate in a free run mode that does not require the use of an external reference.

### Controls and Indicators

SW1 Dipswitch – Used for card programming and configuration.

- Dip1 – ON Disables reference based processing, OFF Enables reference.
- Dip2 – Not currently used.
- Dip3 – Not currently used.
- Dip4 – ON removes CPU from Scangate chain, OFF includes
- Dip5 – ON removes Network Processor from Scangate chain, OFF includes
- Dip6 – ON removes S2022 #1 from Scangate chain, OFF includes
- Dip7 – ON removes S2022 #2 from Scangate chain, OFF includes
- Dip8 – ON places Scangate chain in Bypass mode,
- Normal configuration is DIP1 ON, all others OFF.

SW2 Reset switch - Pressing this switch performs a cold reset of the board.

#### *Indicators*

DS1 – Green – S2022 Processor #1 configured.

DS2 – Green – S2022 Processor #2 configured.

DS3-DS14 – Green – Input Locked - Video channels 1-12 respectively. ON indicates that the video circuit has locked to the incoming video.

DS15, 16 and 17 – Green – Reference locked indicators. In referenced operation, all of these DS18 – Green – ON indicates that the CPU is configured and running.

DS19 – Green –POWER GOOD - ON indicates that all supplies are healthy.

DS20 – Yellow – Comms - ON indicates that the card is being addressed by the router control system.

LED's should be on. In non-referenced operation, they are not meaningful.

P1 is a quad purpose port that is used for standard UT400 diagnostic functions, Ethernet Control Circuit and SMPTE 2022 transmit configuration for both channels. The terminal interface section of this guide contains more information on using diagnostic/configuration port.

There are Four types of indicators on this card –

1. Communications indicator – yellow. Illuminated when the card has been addressed by the Frame Controller Module.
2. PS Fail Led. – Red – Illuminated when one of the board power supplies is out of +- 5% tolerance.
3. Reclocker Locked LED's (12), Green. One of these LED's is present on the front edge of the card for each signal presented to this card. They are labeled as 'RCLK Locked' 1-12.
4. Reference status LED's. Reference present, locked, and aligned LED's indicate the status of the genlock part on the board.

### **Rear Panel Connections**

This card can install into any output slot in a Series 2 router. The rear panel of that slot must be replaced with USI PN 121402-1, SMPTE 2022IO adapter. This adapter has six connections –

1. 100Mbit MGMT ENET LAN connection, via an RJ45. Connect to an Ethernet network using a CAT5 cable. This port is used by USI software applications to manage and control the functions of the card.
2. 10G – 1PRI and 1SEC. Primary/Secondary SFP+ ports for the first SMPTE 2022 channel. This can be fitted with an 10GbE SFP or an SFP Direct Attach cable for connection to an Ethernet switch.
3. 10G – 2PRI and 2SEC – Primary/Secondary SFP+ ports for the second SMPTE 2022 channel. This can be fitted with an 10GbE SFP or an SFP Direct Attach cable for connection to an Ethernet switch.



4. Monitor Port. This can optionally be fitted with a FlexIO SFP to SDI module for SDI monitoring of the signals being packetized on each Ethernet port.

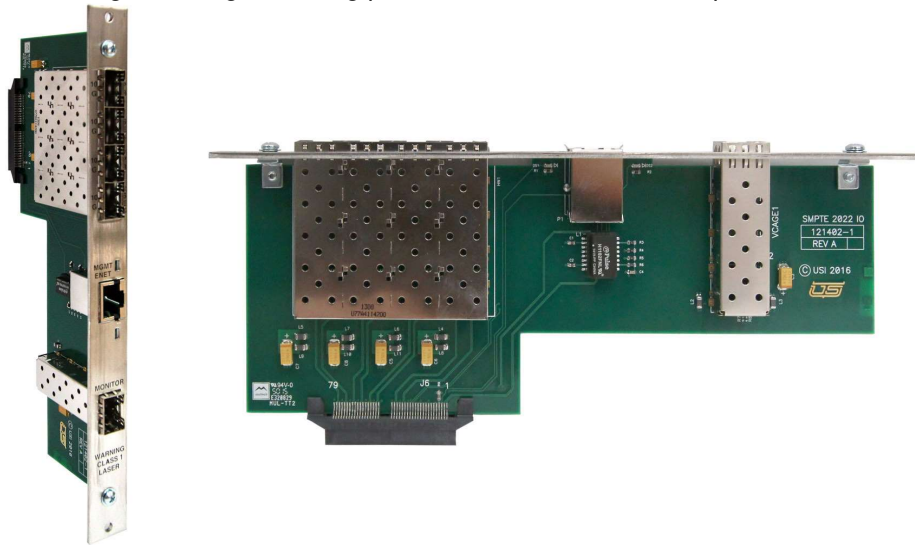

FIGURE 4-46.

---

## Terminal Interface

The P1 serial port is an RS-232 port used to diagnose or configure the card. There are four active devices on the board that communicate out of this port. The user switches between devices by issuing special keyboard commands.

P1 is designed to connect via a straight thru CAT5 or 6 cable to the standard UT400 serial adapter, 140000-8, and then to an RS-232 port on a PC.

A terminal emulation program such as TeraTerm is used to communicate to the board.

The serial port operates at 115.2KBaud, 8 data bits, 1 stop bit and no parity.

The four devices connected to this port are -

- Local monitoring processor. Used to determine overall board state.
- K70 Network Control Layer Processor. Console for Linux network manager.
- 2022 Port #1 Processor. Console for SMPTE stream corresponding to SDI ports 0-5.

- 2022 Port #2 Processor. Console for SMPTE stream corresponding to SDI ports 6-11. To switch between the 4 devices, hold down the CTRL key and press 'p'. Upon each press of this key combination the terminal will report the device connected to the serial port –  
"UBlaze Debug" for the local monitoring processor.  
"K70 Debug" for the network control layer processor.  
"2022 #1 Debug" for the first 2022 processor.  
"2022 #2 Debug" for the second 2022 processor.

The terminal commands available for each port are listed below.

Upon power up, the boards local monitoring processor is connected to the serial port.

### **Local Monitoring Processor Menu –**

S-STATUS  
R-Read Memory  
W-Write Memory  
P-Genlock Read  
O-Genlock Write  
K-Reclocker Read  
T-Toggle in mux  
G-Read Scangate

These menu items are used with support from USI service personnel to diagnose performance of the card.

### **K70 Network Processor Menu –**

This interface is a Linux console that displays or controls functions of the network processor. These menu items are used with support from USI service personnel to diagnose performance of the card.

### **SMPTE 2022 Processor Menu –**

This menu structure is the same for both instances of the SMPTE 2022 transmitter on the card.

There are two main sections to this menu; the first to configure items common to all streams, and a channel specific menu to configure items that are specific to each video stream. A '?' displays the selections in all menus.

### *Main Menu*

-----  
-- VoIP TX Main Menu --  
-----

### *Select option*

1 = Reset Core  
2 = Initialize Core  
3 = Change Primary MAC Address  
4 = Change Secondary MAC Address  
5 = Hitless Protection On/Off  
6 = 10G MAC Fault Inhibit On/Off  
7 = USI Menu  
s = Configure Channel  
p = Probe Current Settings  
? = help  
-----  
>

### *Main Menu Descriptions*

1 – Reset Core. Resets all processing functions.  
2 – Initializes each channel with default values (Note that after a reset, an initialization must be performed).  
3 – Change primary MAC address – Allows the MAC address of the primary link to be changed.  
4 – Change secondary MAC address – Allows the MAC address on the secondary link to be changed.  
5 – Enable or disable hitless (2022-7) Support  
6 – 10G MAC Fault inhibit on/off  
7 – USI Specific diagnostic functions.  
S – Go to channel specific menu (you will be prompted for channel number)  
P – Display current settings.

*Select Channel Menu*

-----  
-- Select Channel --  
-----

Primary Channels

- 1 = Channel 1
- 2 = Channel 2
- 3 = Channel 3
- 4 = Channel 4
- 5 = Channel 5
- 6 = Channel 6

-----

>

Select 1-6 to select the channel number to be configured or monitored.

*Channel Specific Menu*

-----  
-- Select Option --  
-----

- 1 = Channel Init
- 2 = Channel Enable/Disable
- 3 = Change Host IP Address
- 4 = VLAN En/Disable
- 5 = Change VLAN Tag
- 6 = Set Dest MAC Addr
  
- 7 = Set Dest IP Addr
- 8 = Set Source UDP Port
- 9 = Set Dest UDP Port
- 0 = Set SSRC
- a = FEC On/Off
- b = Toggle FEC Level
- c = Set Column FEC
- d = Set Row FEC
- e = Toggle Block Alignment
- f = Time Stamp Include En/Disable
- t = Transmit Enable/Disable
- r = Transmit Packet Count Stat Reset

p = Probe Status  
m = Main Menu  
s = Channel Select

-----

> -

- 1 = Channel Init – Re-initializes settings in the currently selected channel.
- 2 = Channel Enable/Disable – Enables or disables the current channel (toggle)
- 3 = Change Host IP Address – Allows changing the IP address for the current channel.
- 4 = VLAN En/Disable – Toggles the VLAN tagging of outgoing packets
- 5 = Change VLAN Tag – Allows modification of the VLAN tag for the current channel.
- 6 = Set Dest MAC Addr – Set the MAC address of the destination 2022 receiver.
- 7 = Set Dest IP Addr – Sets the IP Address of the destination 2022 receiver.
- 8 = Set Source UDP Port – Sets the UDP port the current channel transmits on.
- 9 = Set Dest UDP Port – Sets the UDP port of the destination 2022 receiver.
- 0 = Set SSRC – Sets the SSRC value in this channels outgoing packets.
- a = FEC On/Off – Enables or disables forward error correction for this channel (toggle)
- b = Toggle FEC Level – Toggle the FEC level for this channel
- c = Set Column FEC – Sets column FEC value for this channel.
- d = Set Row FEC – Sets row FEC for this channel.
- e = Toggle Block Alignment – Toggles FEC Block Alignment.
- f = Time Stamp Include En/Disable – Toggles the inclusion of time stamps.
- t = Transmit Enable/Disable – Enables or disables this channels output. (Toggle)
- r = Transmit Packet Count Stat Reset – Resets counters for this channel.
- p = Probe Status – Displays status of this channel
- m = Main Menu – Return to Main Menu
- s = Channel Select – Return to Channel Select Menu.

*Typical Channel Status report –*

Primary Channel 1  
Channel: Enabled

Dest MAC Address: 08-00-5B-01-00-10  
IP Version: IPv4  
TTL: 128  
TOS: 100  
VLAN: Disabled  
VLAN Tag: 0xAB00  
Source IP Addr: 192.168.5.11  
Dest IP Addr: 192.168.5.10  
Source Port: 0x2710  
Dest Port: 0x2710  
Time Stamp: Enabled  
Video Locked: Locked  
SDI Standard: HD-SDI  
SSRC: 0x12345600  
FEC Size: 77x77  
FEC On/Off: Off  
FEC Level: A  
Block Alignment: Block Aligned  
Transmit Packet Count: 354487 Packets

## **Specifications**

### *Power Consumption*

30 Watts

### *SDI Video*

Supported Video Formats

SMPTE259C – 525 Line and 625 Line

SMPTE292 – 1080i 50/60 Hz, 720P 50/60 Hz

SMPTE424 – 1080P 50/60 Hz, Level A only.

### *10G Ethernet*

The 10G Ethernet Ports on this card support SFF-8431 compliant SFP+ modules or SFP-DA cables not exceeding 2 meters in length.

---

## Rear Panel Considerations

---

---

### *Rear Panel Considerations*

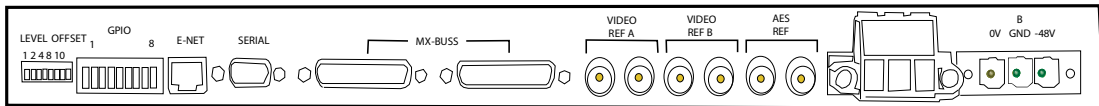

**FIGURE 4-47. Series 2 144x, 288x, 528x, and 1056x**

---

### **MX Bus**

This is the control bus between the UT-400 and an SC-3/4 controller. Each chassis contains two connectors, fed through either side, then distributed to the next piece of equipment from either side.

If this router is at the end of the run (cable), a termination is inserted at the unused side.

### **Dip Switches**

The dip switches are used to set the location of the router within the MX-Bus system. Usage example: A first level, binary setting would require all switches to be placed in the down position. For additional detail, please see “Switch Settings,” on page 2-26.

### **Video Ref A, Video Ref B**

Used as a switching reference. Provides analog blackburst or tri-level sync. This port is a loop thru, and the unused BNC must be terminated in 75 Ohms.

### **AES Ref**

Requires an AES, DARS signal if any synchronous AES routing is operated within the frame.

---

## *Power supplies*

### **External Power Supply**

The additional power supply assembly is a 1 rack unit chassis fed by AC, converting the signal to 48 volts DC.



**FIGURE 4-48. External Power Supply**

---

The power supply interconnects with the router at the bottom of the assembly using a cabled interface. Using Utah Scientific's pre-molded cable assembly, the ground signal and 48 volt conversion are carried to the UT-400 router. You will also see an additional cable assembly that is used for the micro controller inside the router that communicates with the alarm circuitry inside router.

The power supply module contains two redundant card pairs, which convert the 48 volts to 5 volts and 3.3 volts for the router's I/O card.

For mounting and connectivity considerations, the power supply is most appropriately located beneath the UT-400 router.



---

## Power supplies

---

The unique cable assembly allows the micro controller to efficiently communicate, sending accurate alarm signals any time an issue arises.

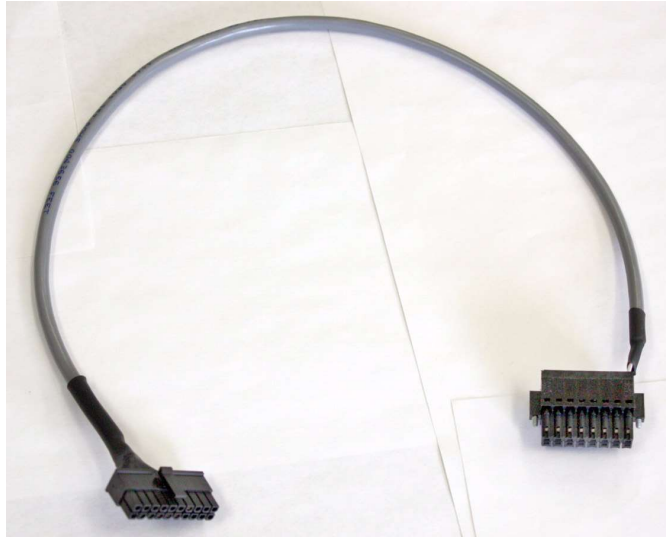

**FIGURE 4-49. Cable Assembly**

---

## Router Power supplies

The Utah-400's power supplies are standard, with AC input, alarm monitoring circuitry, and DC output going to the system.

### LED Indications

If no alarms are present, the ALM LED will be off while the yellow LEDs (AC OK and DC OK) will be illuminated.

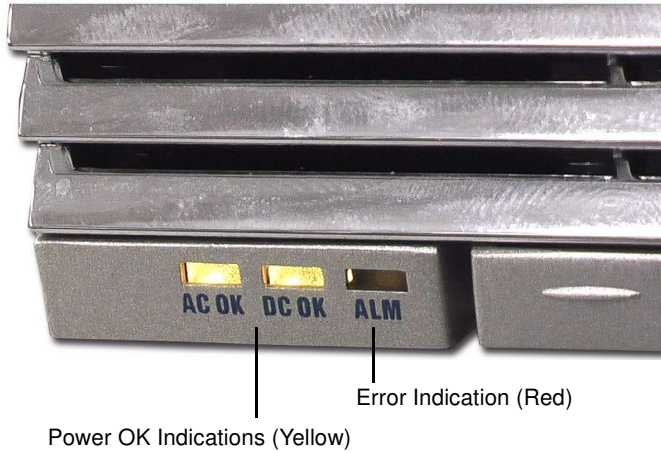

**FIGURE 4-50. Power Supply**

Individual supply alarms will be indicated with the corresponding red LED. Specific adjustments are available for individual voltage indications within this guide's Troubleshooting section.

The LED is viewable on the front cover through the lightpipe.

---

**Power supplies**

---



# Troubleshooting

---

**Note: Parts of this section were derived from the Utah-200 Manual; some areas may not apply directly to the Utah-400 but will be corrected in the next version of this manual.**

---

## *In This Chapter*

This chapter is designed to help the user diagnose problems on the Utah-400 Routers to the subsystem level. There are no repairable boards in the Utah-400 system, contact Utah Scientific Technical Services at 800-447-7204 regarding any problems you may be having. Should any printed circuit boards need repair, Technical Services can advise you on shipping and on the repair process.

Subsystem Level Troubleshooting .....	5-2
Main Troubleshooting Chart .....	5-2
Video Subsystem Troubleshooting Table .....	5-4
Audio Subsystem Troubleshooting Table .....	5-5
Power Subsystem Troubleshooting Table .....	5-6
Power Supply Alarms .....	5-6
Control Subsystem Troubleshooting Table .....	5-7
System Controller Alarms .....	5-8
Control Panel Troubleshooting .....	5-9
UNET Panels .....	5-9
Ethernet Panels .....	5-9

---

## *Subsystem Level Troubleshooting*

A routing system is typically comprised of several subsystems:

- Video System
- Audio System
- Control System
- Power System

Fault finding is simplified by first isolating the problem to one of these subsystems. For example, if the audio-system is functioning normally, but there are problems with video, the problem is probably confined to the video system.

***Note: With the exception of a system using Digital Video with embedded audio, audio signals are switched through a different matrix than the video signals.***

---

## *Main Troubleshooting Chart*

The following table provides an indication of what subsystems should be reviewed for common problems.

Please note:

- The numbers shown in the four Subsystem Table Reference columns indicate specific troubleshooting problems that are found in the four individual Subsystem Tables.
- For example: a 1 listed under the Video column refers to problem number 1 in the "Video Subsystem Table" on the following page. Here you will find a list of specific checks that will assist in troubleshooting the problem.

---

**Main Troubleshooting Chart**

---

**TABLE 2-1. Main Troubleshooting Table**

Problem	Subsystem Table Reference			
	Video	Audio	Power	Control
No Video or Audio outputs	1	1	1,2	1
Video and Audio outputs are present but neither can be switched	2,3	2,3		1,2,6
No Video output, Audio functions normally	1,2,3		1	2
No Audio output, Video functions normally		1,2,3	2	2
Video switches normally but audio does not switch		2,3		2
Audio switches normally but the video does not switch	2,3			2
Flash on video when switching	4			
Cannot access expansion inputs or outputs of video level	5			
Audio signal level incorrect		4		
Video signal level incorrect	7			
Video signal anomaly	5,6,8			
Video monitor matrix not functional	9			
Audio monitor matrix not functional		5		
Control panel does not function				1,2,3
Control via serial port not functional				4
Ethernet control port not functional				5
Alarm port active			3	6
SC-3/4 Ports not "Active"			3,4	4,5
Undefined level types in SC-3/4 Controller				1,2,4

## Video Subsystem Troubleshooting Table

Use the following table to troubleshoot specific video subsystem problems. The numbers in the left-hand column indicate specific references from the Video column in the **Main Troubleshooting Table**.

**TABLE 2-2. Video Subsystem Troubleshooting Table**

Problem		Check
1	No video output	<ul style="list-style-type: none"> <li>• Control cable connected, or internal controller functional?</li> <li>• Different input works on output bus?</li> <li>• Other outputs functional?</li> </ul>
2	Unable to select a specific input	<ul style="list-style-type: none"> <li>• Control panel programming correct?</li> <li>• Output signal level locked or protected?</li> </ul>
3	Unable to select any input	<ul style="list-style-type: none"> <li>• Control cable connected?</li> <li>• Control panel defective?</li> <li>• Controller failure?</li> </ul>
4	Video flash when switching between inputs	<ul style="list-style-type: none"> <li>• Input sources timed correctly?</li> <li>• Input reference signal present and timed?</li> <li>• Input reference correct standard?</li> <li>• Correct video standard jumper set on controller board?</li> </ul>
5	Inputs / Outputs inaccessible	<ul style="list-style-type: none"> <li>• Expansion matrix crosspoint cards present?</li> </ul>
6	Sync missing on video output (analog)	<ul style="list-style-type: none"> <li>• Sync present on selected input?</li> <li>• Normal DC level on input?</li> </ul>
7	Video output level incorrect	<ul style="list-style-type: none"> <li>• Input level correct</li> <li>• Output terminated at destination (analog)?</li> <li>• Input/output compensation jumpers correctly set?</li> </ul>
8	Sparkles on video output (digital)	<ul style="list-style-type: none"> <li>• Input signal amplitude too low?</li> <li>• Cable length &gt; 300 meters on input?</li> </ul>
9	Monitor Matrix not functional	<ul style="list-style-type: none"> <li>• Selected correctly on control panel?</li> </ul>



---

## *Audio Subsystem Troubleshooting Table*

Use the following table to troubleshoot specific audio subsystem problems. The numbers in the left-hand column indicate specific references from the Audio column in the Main Troubleshooting Table.

**TABLE 2-3. Audio Subsystem Troubleshooting Table**

Problem	Check
1	No audio output <ul style="list-style-type: none"><li>• Control cable connected, or internal controller functional?</li><li>• Different input works on output bus?</li><li>• Other outputs functional?</li></ul>
2	Unable to select a specific input <ul style="list-style-type: none"><li>• Control panel programming correct?</li><li>• Output signal level locked or protected?</li></ul>
3	Unable to select any input <ul style="list-style-type: none"><li>• Control cable connected?</li><li>• Control panel defective?</li><li>• Controller failure?</li></ul>
4	Output level incorrect (analog) <ul style="list-style-type: none"><li>• Input level correct?</li><li>• Input termination in correct position?</li><li>• Output termination in correct position?</li></ul>
5	Monitor Matrix not functional <ul style="list-style-type: none"><li>• Selected correctly on control panel?</li></ul>

## Power Subsystem Troubleshooting Table

Use the following table to troubleshoot specific power subsystem problems. The numbers in the left-hand column indicate specific references from the Power column in the **Main Troubleshooting Table**.

**TABLE 2-4. Power Subsystem Troubleshooting Table**

Problem	Check
1	No video output <ul style="list-style-type: none"> <li>• Power applied to video frame?</li> <li>• Warning indicators on the front of each power supply?</li> <li>• Control cable between chassis connected?</li> </ul>
2	No audio output <ul style="list-style-type: none"> <li>• Power applied to audio frame?</li> <li>• Warning indicators on the front of each power supply?</li> <li>• Control cable between chassis connected?</li> </ul>
3	Alarm active <ul style="list-style-type: none"> <li>• Voltage alarm active (LED on)?</li> <li>• Fan alarm active (LED on)?</li> <li>• Temperature alarm active (LED on)?</li> </ul>
4	Controller power <ul style="list-style-type: none"> <li>• Power applied to controller frame?</li> </ul>

## Power Supply Alarms

Power supply alarms are indicated by red LEDs on the front of each power supply module. They consist of voltage, fan, and temperature alarms.

- The voltage alarm indicates that one of the supply voltages is either too high or too low.
- The fan alarm indicates that the fan has stalled.
- The temperature alarm indicates that the temperature is elevated in the power supply. This may be caused by dirt or dust blocking the airway, a defective cooling fan, or by operation in extreme temperatures.

**Note:** *Optional redundant power supplies may be fitted to UTAH-400 systems. In this configuration, the failure of a power supply should not affect normal system operations, but users would be unaware of the power supply failure. Thus, it is highly advisable to utilize the SMPTE alarm output provided at the rear of the chassis.*

## Control Subsystem Troubleshooting Table

Use the following table to troubleshoot specific control subsystem problems. The numbers in the left-hand column indicate specific references from the Control column in the **Main Troubleshooting Table**.

**TABLE 2-5. Control Subsystem Troubleshooting Table**

Problem	Check
1	No control of any level <ul style="list-style-type: none"> <li>• Internal controller operating (see below)</li> <li>• External controller connected</li> <li>• Control panels connected (see below)</li> <li>• MX bus terminated (see below)</li> <li>• U-Net terminated (see below)</li> <li>• Completed controller software upgrade</li> </ul>
2	No control of individual signal level or levels <ul style="list-style-type: none"> <li>• MX bus cable connected (see below)</li> <li>• MX bus correctly terminated (see below)</li> <li>• Is non functional signal level address set correctly (see below).</li> <li>• Control panel programmed correctly (see "Operations")</li> <li>• Output locked or protected on that level (see "Operations")</li> </ul>
3	Control panel not functional <ul style="list-style-type: none"> <li>• Panel address set to unique number</li> <li>• Completed panel software upgrade</li> </ul>
4	Serial control port not functional <ul style="list-style-type: none"> <li>• Communications baud rate incorrect</li> <li>• Serial control Protocol incorrect</li> <li>• Serial control cable wired correctly</li> </ul>
5	Ethernet port not functional <ul style="list-style-type: none"> <li>• Ethernet option fitted</li> <li>• Connected to PC directly by null cable</li> <li>• Connected to network via gateway</li> </ul>
6	Alarm active <ul style="list-style-type: none"> <li>• Active CPU indicator extinguished (SC-4)</li> <li>• Heartbeat indicator extinguished (SC-4)</li> <li>• MX activity light does not flash (SC-4)</li> </ul>

---

## *System Controller Alarms*

System controller alarms are indicated by LEDs on the front of each controller card.

- The active LED should be lit on one of the controller cards. If only one controller is present (non redundant system), the active LED should be illuminated.

Please note the following additional points regarding the controller:

- The heartbeat LED (DS6) indicates that the processor is communicating with the vital parts of the system and is running the application software.
- The MX LEDs indicates communication with the crosspoint matrix. The transmit LED (DS8) will flash whenever communication is being made from the controller to the matrix. The receive LED (DS7) will flash whenever communication is being received by the controller from the matrix.
- U-Net is used for communication between the controller and the control panels. The U-Net data and U-Net transmit enable LEDs (DS9 and DS10) indicate when information is exchanged between the system controller and a control panel.
- If the active LED is on and the U-Net transmit enable LED (DS10) is off, this indicates that a controller software upgrade has failed and the controller is waiting for a valid controller software upgrade to be uploaded.
- If used with an SC-4 or SC-400 system controller consult the appropriate controller manual for details about the controller card.
- The total MX bus cable length must be less than 300 feet and must be terminated at the last chassis.

---

## *Control Panel Troubleshooting*

If your control panel does not control any of the matrix, check that power is applied to the panel.

### **UNET Panels**

- Panels communicate to the controller by a special network known as U-Net. Panels are connected together daisy chain style to the controller. Removing a panel physically from the network will break the chain and disconnect panels downstream from the controller.
- U-Net uses unshielded twisted pair cable. It requires two twisted pairs terminated in an RJ 45 connector. The maximum length of any segment is 1000 feet and must be terminated at the last control panel in each segment. Refer to the Appendix C "U-Net Cabling" for details.
- The panel may be communicating to the controller correctly, but the required signal level matrix may not be responding. Check the Dipswitch setting on the rear panel of the non-functional router level.

***Confirm that the control panel address is a unique number. Each panel address is set by a rear panel Dipswitch and must be a unique address. This control panel address is read when the control panel is powered up.***

### **Ethernet Panels**

- Panels should be connected to the same network as the SC-3/4 controller.
- There should be a network hub between a panel and the SC-3/4 controller.
- Unique IP addresses.
- CAT-5 cable lengths should be less than 100 meters.



# *Specifications*

---

## *In this Appendix*

This appendix provides detailed lists of all system audio, video, control, physical, power and regulatory specifications.

Power .....	A-2
Input Power and DC Power Specifications .....	A-2
Digital Video .....	A-3
Reference .....	A-5
Control .....	A-6
Alarms .....	A-6
Physical .....	A-7
Regulatory .....	A-8
Connector Suppliers and USI Part Numbers .....	A-9
Connector Suppliers .....	A-9

---

**Specifications**

---

---

*Power*

The following table lists power specifications:

---

*Input Power and DC Power Specifications*

**TABLE A-1. Input and DC specifications**

---

<b>Parameter</b>	<b>Specification</b>
<b>(AC Supply)</b>	
Input Power Consumption	1250 Watts per module, max
Voltage	90 - 240 Volts AC, universal power supply
Frequency	50 - 60 Hertz
Redundancy	Quad 1250 w/ rectifiers standard, only 2 required to run system
<b>DC Output Voltages (From external supply)</b>	
48 volts	35 Amps, max



---

*Digital Video*

The following table lists the system digital video specifications.

**TABLE A-2. Digital Video Specifications**

---

Jitter	Conforms to SMPTE 259, 292, 424
Reclocked Data Rates	270, 1485, 2970, Mb/Sec
Input Return Loss	< -15 dB to 1.5 Ghz, -10dB to 3Ghz
Output Return Loss	< -15 dB to 1.5 Ghz, -10dB to 3Ghz
Input EQ level	
Belden 1694A cable	> 300 M @ 270 Mb/Sec > 150 M @ 1.485 Gb/Sec > 100 M @ 2.970 Gb/Sec

**Digital Audio Specifications****TABLE A-3.**

---

<b>Parameter</b>	<b>Specification</b>
<b>Digital Audio Processing</b>	48 kHz. 16 - 24 Bit, AES / EBU; AES-3
<b>Input Impedance - Balanced</b>	110 $\frac{3}{4}$ $\pm$ 20%. 100 KHz. to 6.144 MHz
Input Level minimum:	200 mVPP. w/> 50% Eye Pattern Opening
Modes of Operation	Synchronous and Asynchronous
Input Level maximum:	7 VPP
Common Mode Range:	$\pm$ 7V (DC + Peak Signal)
Common Mode Rejection:	Per AES-3, Section 6.3.5 (1997)
Output Impedance - Balanced	110 $\frac{3}{4}$ $\pm$ 20%, 100 kHz. to 6.144 MHz
Output Amplitude:	2.0 VPP into 110 $\frac{3}{4}$ , minimum
Nominal Rise / Fall Times:	25 nano seconds
Common Mode Rejection:	>30 dB, DC to 6 MHz
Sample Rate:	48 kHz
Intrinsic Jitter:	< 0.025 UI Peak, w/700 Hz. HPFApplies to discrete AES outputs
Output Phasing with respect to DARS Input:	$\pm$ 2.5% ( $\pm$ 9 $^{\circ}$ ) of Frame Interval.Applies to discrete AES outputs

---

**Reference**

---

---

*Reference*

The table below lists reference specifications

**Reference Specifications****TABLE A-4.**

<b>Parameter</b>	<b>Specification</b>
Audio	One 75Ohm terminated AES sync
Video 1	NTSC or PAL black burst, or Tri-Level Sync
Video 2	NTSC or PAL black burst, or Tri-Level Sync

---

## *Control*

The following table lists control specifications:

### **Control Specifications**

TABLE A-5.

<b>Parameter</b>	<b>Specification</b>
Control	MX-Bus Daisy Chain - Terminated
Audio	One AES Audio Sync

---

## *Alarms*

The following table lists alarm specifications:

### **Alarm Specifications**

TABLE A-6.

<b>Parameter</b>	<b>Specification</b>
Primary alarm	ANSI / SMPTE 269M fault reporting (Relay closure)
Connector Type	Phoenix Male Barrier Strip – 3 pin
Functions	<ul style="list-style-type: none"><li>• Power</li><li>• Temperature</li><li>• Fans</li><li>• System Board Failure</li></ul>
Maximum current	20 milli-Amp

---

**Physical**

---

---

*Physical*

---

The following table lists physical specifications:

**Physical Specifications****TABLE A-7.**

---

<b>Parameter</b>	<b>Specification</b>
Width	EIA – RS-310 – D 92 19” rack mount standard
Height	20 rack units for the 528 (300 lbs.), and 40 rack units for the
Depth	400 XL (600 lbs.) <sup>a</sup>
Weight	19 inches, 483 mm maximum
Mounting	150 pounds
System connectors	Eight front mount rack ears
Cooling	All connectors rear panel mounted
Temperature range	8 Fans – side exhaust 528, 16 fans for XL
Humidity range	10 – 40 Degrees Celsius 0 – 90% non - condensing

---

a. - The power supply adds one rack unit to the 528, and 2 rack units to the 400 XL

---

**Specifications**

---

---

*Regulatory*

The following table lists system regulatory specifications

**Regulatory Specifications****TABLE A-8.**

---

<b>Parameter</b>	<b>Specification</b>
EMC	EN50 081-1 (EN50 022 Class A)
Susceptibility	EN50 082 (IEC 801-3, IEC 801-4)
Safety	EN60 950, UL 1950, CSA 022.2 No. 234
Shock / Vibration	MIL Std. 810E, Method 514.4(cargo truck 500 / 500 miles)

---

***Connector Suppliers and USI Part Numbers***

The following table lists connector supplies and Utah Scientific Part Numbers where applicable: Not all connectors are used on the Utah-400 but are supplied as a courtesy.

**Connector Suppliers**

**TABLE A-9.**

<b>Manufacturer Part Description</b>	<b>Part Number</b>	<b>USI Part No.</b>	<b>Contact</b>
Advanced Connectek USA Inc.			714 – 573-1920
<ul style="list-style-type: none"> <li>DB-26B – Male connector, crimp</li> </ul>	DH-26PK-SFG-T	41226-2026	
Conec Corp.			Ontario, Canada 905 – 790-2200 American Conec Corp. 102 Pleasant Wood Ct. Morrisville, NC 27560 (919) 460-8800
<ul style="list-style-type: none"> <li>DB-26B – Male connector, solder cup</li> </ul>	CDS26LFHD SN163A1660 9X	41226-3026	
Amp			AMP Inc. Harrisburg, PA 17105 (800) 522 – 6752
<ul style="list-style-type: none"> <li>BNC Male connector</li> </ul>	225395-2 5-569278-2	41215-0001 41211-0011	
<ul style="list-style-type: none"> <li>RJ-45 Male connector</li> </ul>	747904-2	41223-1009	
<ul style="list-style-type: none"> <li>DB-9B Male connector</li> </ul>			
Phyco			Kimball Electronics 1600 Royal St.; GO-149 Jasper, IN 47549 (800) 634-9497
<ul style="list-style-type: none"> <li>6 pin CirDin</li> </ul>	A-9001-069	41329-1006	

---

**Specifications**

---



**Diagnostic Port Usage**

Every device within the Series 2 router that has an on board microprocessor has an RS-232 DTE port that can be used to configure, gather status, or perform updates to the card. This section describes the commands and status information generated by these ports, with each device or group of similar devices having its own section.

**Physical Connections**

There are two types of physical connection for these ports, a DB-9 female labeled 'Serial' on the router rear panel for the system Frame Controller Module pair, and an RJ-45 connector on the board front edge for everything else.

For the FCM connection, the pinout is detailed on page 2-28 of this manual. Everything else uses a DB9 to RJ-45 adapter, USI Part Number 140000-9, and a length of standard CAT5 patch cord for its connection.

**Baud Rate and terminal Settings**

For all connections, use these baud settings in your terminal emulation program.

<b>Item</b>	<b>Setting</b>
Baud	38400
Data Bits	8
Stop Bits	1
Parity	None
Handshaking	XON/XOFF

## Terminal Settings

For all connections, an ASCII translation of CR to CR/LF needs to be applied to the receive side of the terminal emulation program.

## Recommended Terminal Emulation Program

It is recommended that the 'TeraTerm' shareware program, which is included in all Utah Scientific System CD's, be used when communicating to the router. It is also recommended that a PERMANENT connection between the Utah Scientific control computer and the router FCM be put in place for diagnostics.

## System Diagnostics – Frame Controller Module

The FCM in the system gathers information from all the devices and determines when to change the system operation based upon what it received. It controls which crosspoint card is actually passing signal and which is standby, sets or clears alarms, and reports status to the SC4 over MX Bus.

The serial port on the FCM has a command-response type interface that allows you to determine how it is operating. Pressing the space bar will show you a list of available commands. Below is a description of the status reported. The text in italics is an explanation. This list is based on the current SW version, V1.21

```
    'M' -
FPGA MEMORY STATUS
Level Switch   = 00      (System Level Dipswitch)
Offset Switch  = 00      (System Offset Dipswitch)
MX Active?     -> No.    (State of MX Connection)
Monitor Matrix = 000     (Monitor Matrix Crosspoint)
Primary-ID Reg = 5103    (ID Code in upper byte)
Audio-ID Reg   = 5959    (ID Code for Audio subrouter in upper byte)
FPGA Rev       = 1.09    (FW Revision in FPGA)
Sync Sel Reg   = 00      (Which Sync source is being used)
Alarm Led Reg  = 00      (Alarm Register)
Sync1 Stat Reg = E465    (Lines Per Frame of ref signal -lower 3 digits hex)
Sync2 Stat Reg = 0000
IRQ Mask Reg   = 01      (DEBUG)
IRQ Stat Reg   = 00      (DEBUG)
Test Point Reg = 00      (DEBUG)
Board Pres Reg = 50-61-08-20-80-10-00-00-00-00-80 (Array of Installed IO)
XPT Pres Reg   = 19      (Crosspoints Installed and Active)
MX Err Reg     = FF      (Error Code being reported FF=No Alarm)
Change Reg     = 67      (Change Reg - Increments at each event)
```

---

'S' -

Error Summary - Fans OK- EXT PS OK- XPT's OK- IO Cards OK.

FCM PN-Rev = 1228-1002 SN = 0142 CONF SW = 1E  
EXT PS ALM POLARITY = CLOSED (Reports ALM Pol Setting)  
System Type -> 528 System - In 528 Chassis. (System Type)  
Slot = Redundant (Slot of the currently active FCM)  
Local Voltage Levels (Power Supplies)  
5V = 5044mv  
3.3V = 3302mv  
2.5V = 2483mv  
1.2V = 1222mv  
-5V = 1859mv  
Fan Module 1 OK - Fan Module 2 OK : 0100 (FAN Status)  
GPIO Registers = 0F (GPIO Input Status)

'I' -

IO card raw status

	PN-rev	SPD	SN	IC	TM	VR	ER	X1	X2	X3	E1	E2
Card 4	- 12921011	0000	0901	12	28	21	00					
Card 11	- 12921011	0000	0901	12	27	21	00					
Card 22	- 123010B9	FF0F	0935	14	3B	21	00	00	00	00	FF	FF
Card 24	- 12931000	BF0C	0106	21	4A	10	00	00	00	00	10	10
Card 27	- 12931000	DD0F	0108	22	47	10	00	00	00	00	10	10
Card 28	- 12301001	7F00	0112	12	3C	21	00	00	00	00	FF	FF
Card 35	- 12301001	FF0F	1073	0F	1B	21	00	00	00	00	FF	FF
Card 41	- 13171007	FF0F	0115	0C	18	22	00	00	00	00	00	00
Card 42	- 12301001	FF0F	0123	12	14	20	00	00	00	00	FF	FF
Card 87	- 12301001	4000	0116	11	12	21	00	00	00	00	FF	FF

Xpt card status

	PN-rev	CUR	VER	ERR	SN
Card 0	- 12221001	2A	A8	00	0192
Card 2	- 13231006	00	11	00	0100

---

The Debug Port

---

MMtrx card status  
PN-rev VER ERR SN IC TM  
122710A0 21 00 0901 12 28

Descriptions of the above status reports -

- PN-REV - The PN-REV column shows the USI part number of the card in the first 4 digits, the sub part number in the digits 5-6, and the revision in digits 7-8.
- SPD - Signal Presence Detect column. The first 2 digits are for IO 1-8 of that card, the last digit is for IO 8-11, and the third digit is for TDM lock on TDM enabled cards.
- SN - Board Serial Number
- IC - Board power dissipation in watts.
- TM - Board temperature in degrees Celsius.
- VR - Version of IO card firmware.
- X1-X3 - Shows setting of crosspoint card mux for all 12 outputs.
- E1-E2 - Shows enable status for the 12 outputs on an output card.

      'v' -  
\*\*\*\*\*  
          Utah Scientific Inc.  
Utah-400 528-XL Video System Monitor, Rev. 1.21  
\*\*\*\*\*

---

In addition to the commands in the menu, there are several hidden commands that can be useful.

'A' command – Display information relating to the Audio Subrouter, if present

'P' command – Set system Alarm GPI Polarity.

'E' command – Display the number of times each card has been reset

'C' command – Clear the reset counters.

Also, there are some displays on the FCM terminal that are unsolicited, that the FCM reports when there has been a system error detected. Each device that the FCM talks to reports an error byte back to the FCM, that is visible in the 'I' command above. Some errors are not persistent, so the FCM reports them whenever they happen. They follow this type of format –

X YY ZZ

X is the card type (L for line card and X for crosspoint).

YY is the Address of the device, the same as the slot number.

***Note that this number is 0 based, and represented in hexadecimal.***

ZZ is the error data being reported, in a binary format.

For example, the report 'L 25 01' is an event from a Line card in slot 25, and the error code is 0x01. The report 'X 01 A0' is from a crosspoint card, in slot 1, and its error codes were 0x20 AND 0x80. A list of the currently defined error codes is below –

Line cards –

0X01	Board was just reset or powered up.
0x02	Signal Presence Detect Changed
0x04	Fiber Module Changed (1234, 1235 only)
0x08	Hardware Fault
0x10	Mux Select For outs 1-4 changed (1230, 1235, 1293, 1317 only)
0x20	Mux Select For outs 5-8 changed (1230, 1235, 1293, 1317 only)
0x40	Mux Select For outs 9-12 changed (1230, 1235, 1293, 1317 only)
0x80	Enable changed (1230, 1235, 1293, 1317 only)

## Crosspoint cards –

0X01	Power / Temperature Error
0x02	Crosspoint communication Error
0x04	Seating Error
0x08	
0x10	Level Changed
0x20	Offset Changed
0x40	System Type Changed (XL/528)
0x80	Board was just reset or powered up.

---

---

## 121222-1 Crosspoint card Diagnostic Interface

This serial port connection returns data for just the crosspoint card. It is useful to diagnose error codes reported by the crosspoint, and to determine status. Pressing the space bar will show you a list of available commands. Below is a description of the status reported. The text in italics is an explanation. This list is based on the current SW version, V2.00

'M' -

```
FPGA MEMORY STATUS
Level Switch = 00          (Level setting, should match FCM)
Offset Switch = 00        (Offset setting, should match FCM)
SysType fr FCM= 00        (00 = 528, 40 = XL Lower, C0 = XL Upper)
Decoded IO Val= 00        (Bit 8,7 = Always 0.
                           Bit 6 = 1=In Offset 1056, 0=No XL Offset
                           Bit 5 = 1=Out Offset 528, 0=No Output Offset
                           Bit 4 = 1= Center XL Slot, 0= Not
                           Bit 3 = 1= XL+Offset, 0= Not
                           Bits 2-1 = x256 Out Range Multiplier)

MX Active? -> No.         (State of MX Bus)
Seating Register = 00     (All 0 if properly seated)
Slot ID Register = 00     (0, 1, 2 or 3 in 528, 4, 5, 6, or 7 in XL)
Primary / ID Reg = 53     (Device Type, 51=528, 52=XLLWR, 53=XLUPR)
FPGA Rev = 2.02           (Revision of FPGA Code)
User Switch = 00 | 00     (SG User Switch Setting)

'V' -
```

```
*****
                Utah Scientific Inc.
Utah-400-528 Routing System Monitor, Rev. 2.00
*****
```

\R' -

ROUTER STATUS

Ot000 000,000,000,000,000,000,000,000,000,000,000,000,001,000,001,000,  
Ot010 001,000,001,000,001,000,001,000,000,000,000,000,000,000,000,000,  
Ot020 000,000,000,000,000,000,000,000,000,000,000,000,000,000,000,  
Ot030 000,000,000,000,000,000,000,000,000,000,000,000,000,000,000,  
Ot040 000,000,000,000,000,000,000,000,000,000,000,000,000,000,3FF,  
Ot050 3FF,3FF,3FF,3FF,000,000,000,000,000,000,000,000,000,000,000,  
Ot060 000,000,000,000,000,000,000,000,000,000,000,000,000,000,000,  
Ot070 000,000,000,000,000,000,000,000,000,000,000,000,000,000,000,  
Ot080 000,000,000,000,000,000,000,000,000,000,000,000,000,000,000,  
Ot090 000,000,000,000,000,000,000,000,000,000,000,000,000,000,000,  
Ot0A0 000,000,000,000,000,000,000,000,000,000,000,3FF,3FF,3FF,3FF,3FF,  
Ot0B0 3FF,3FF,3FF,3FF,3FF,3FF,3FF,3FF,3FF,3FF,3FF,3FF,3FF,3FF,3FF,  
Ot0C0 3FF,3FF,3FF,3FF,3FF,3FF,3FF,3FF,3FF,3FF,3FF,3FF,3FF,3FF,3FF,  
Ot0D0 3FF,3FF,3FF,3FF,3FF,3FF,3FF,3FF,3FF,3FF,3FF,3FF,3FF,3FF,3FF,  
Ot0E0 3FF,3FF,000,000,000,000,000,000,000,000,000,000,000,000,000,  
Ot0F0 000,000,000,000,000,000,000,000,000,000,000,000,000,000,000,  
Ot100 003,003,000,000,000,000,000,000,



---

`S' -

HARDWARE STATUS

Crosspoint type = 576X288 XPT

Part Number = 1222-1001

Total Power = 42W

Error Summary - Seating OK - XP Comms OK - XP Power OK.

XPT1 IO voltage = 1820 mV

XPT2 IO voltage = 1846 mV

XPT3 IO voltage = 1794 mV

XPT4 IO voltage = 1794 mV

XPT1 Core voltage = 1157 mV

XPT2 Core voltage = 1170 mV

XPT3 Core voltage = 1183 mV

XPT4 Core voltage = 1183 mV

MAX ADC Wait = 1

Crosspoint Readback

J71 XP1 = 05C0

J71 XP2 = 05C0

J45 XP1 = 05C0

J45 XP2 = 05C0

J70 XP1 = 05C0

J70 XP2 = 05C0

J44 XP1 = 05C0

J44 XP2 = 05C0

XP Enable Reg (good = 0F) = 0F

### 121323-1 TDM Audio Crosspoint Carrier for 528 Systems Diagnostic Interface

This serial port connection returns data for just the crosspoint card. It is useful to diagnose error codes reported by the crosspoint, and to determine status. Pressing the space bar will show you a list of available commands. Below is a description of the status reported. The text in italics is an explanation. This list is based on the current SW version, V1.00

```
`M' -
FPGA MEMORY STATUS
Level Switch = 00      (Level Setting - Should Match FCM)
Offset Switch = 00    (Offset Switch - Should Match FCM)
MX Active?  ->  No.   (MX Activity)
MMX Value = 0000      (MMX Crosspoint)
Seating Register = 00 (Should be all 0 if board seated properly)
Slot ID Register = 00 (00 or 01)
Primary / ID Reg = 53 (MX Bus ID 0x53)
FPGA Rev = 0.05       (FPGA Revision)
User Switch = 00 | 00 (SG User Switch Value)
```

```
`V' -
*****
                Utah Scientific Inc.
Utah-400-528 TDM XPT System Monitor, Rev. 1.00
*****
```

---

---

```
`R' -  
TDM Port 0 (0000-0191) =  
Ot000 005,000,000,000,000,000,000,000,000,000,000,000,000,000,000,000,000,000,000,  
Ot010 000,000,000,000,000,000,000,000,000,000,000,000,000,000,000,000,000,000,  
Ot020 000,000,000,FFF,FFF,FFF,FFF,FFF,FFF,FFF,FFF,FFF,FFF,000,FFF,FFF,  
Ot030 FFF,FFF,FFF,FFF,FFF,FFF,FFF,FFF,FFF,FFF,FFF,FFF,FFF,FFF,FFF,FFF,  
Ot040 FFF,FFF,FFF,FFF,FFF,FFF,FFF,FFF,FFF,FFF,FFF,FFF,FFF,FFF,FFF,FFF,  
Ot050 FFF,FFF,FFF,FFF,FFF,FFF,FFF,FFF,FFF,FFF,FFF,FFF,FFF,FFF,FFF,FFF,  
Ot060 FFF,FFF,FFF,FFF,FFF,FFF,FFF,FFF,FFF,FFF,FFF,FFF,FFF,FFF,FFF,FFF,  
Ot070 FFF,FFF,FFF,FFF,FFF,FFF,FFF,FFF,FFF,FFF,FFF,FFF,FFF,FFF,FFF,FFF,  
Ot080 FFF,FFF,FFF,FFF,FFF,FFF,FFF,FFF,FFF,FFF,FFF,FFF,FFF,FFF,FFF,FFF,  
Ot090 FFF,FFF,FFF,FFF,FFF,FFF,FFF,FFF,FFF,FFF,FFF,FFF,FFF,FFF,FFF,FFF,  
Ot0A0 FFF,FFF,FFF,FFF,FFF,FFF,FFF,FFF,FFF,FFF,FFF,FFF,FFF,FFF,FFF,FFF,  
Ot0B0 FFF,FFF,FFF,FFF,FFF,FFF,FFF,FFF,FFF,FFF,FFF,FFF,FFF,FFF,FFF,FFF,  
  
TDM Port 1 (0256-0447) =  
Ot000 FFF,FFF,FFF,FFF,FFF,FFF,FFF,FFF,FFF,FFF,FFF,FFF,FFF,FFF,FFF,FFF,  
--Continued --
```

This 'R' command shows crosspoint status of all possible 2304 outputs, segregated by TDM bus. Only a portion is shown here for brevity.

```
`S' -  
HARDWARE STATUS  
Crosspoint type = 12x12 TDM XPT  
Part Number = 1323-1008  
Total Power = 10W  
Error Summary - Seating OK - XP Comms OK - XP Power OK.
```

```
Crosspoint Readback  
XP1 = 036C01000003001B (First 4 digits, 036C, are a Semaphore)  
XP2 = 036C01000003001B (Next 4 digits, 0100, are firmware version)  
XP3 = 036C01000003001B (Next 4 digits, 0003, show presence of ACLK and FSYNC)  
XP4 = 036C01000003001B (Next 4 digits, 001B, show which TDM inputs are present)  
XP Enable Reg (good = 0F) = 0F (0F indicates all crosspoint modules healthy.)
```

### 121248-1 Crosspoint card Diagnostic Interface

This serial port connection returns data for just the crosspoint card. It is useful to diagnose error codes reported by the crosspoint, and to determine status. Pressing the space bar will show you a list of available commands. Below is a description of the status reported. The text in italics is an explanation. This list is based on the current SW version, V1.02

```
`M' -  
FPGA MEMORY STATUS  
Level Switch = 00      (Level Setting - Should Match FCM)  
Offset Switch = 00    (Offset Switch - Should Match FCM)  
MX Active?  ->  No.   (MX Activity)  
MMX Value = 0000     (MMX Crosspoint)  
Seating Register = 00 (Should be all 0 if board seated properly)  
Slot ID Register = 00 (00 or 01)  
Primary / ID Reg = 53 (MX Bus ID 0x53)  
FPGA Rev = 0.05      (FPGA Revision)  
User Switch = 00 | 00 (SG User Switch Value)
```

```
`V' -  
*****  
                Utah Scientific Inc.  
Utah-400-528 TDM XPT System Monitor, Rev. 1.00  
*****
```

---

\R' -

ROUTER STATUS

Ot00 3FF,3FF,3FF,3FF,3FF,3FF,3FF,3FF,3FF,3FF,3FF,3FF,3FF,3FF,3FF,  
Ot10 3FF,3FF,3FF,3FF,3FF,3FF,3FF,3FF,3FF,3FF,3FF,3FF,3FF,3FF,3FF,  
Ot20 3FF,3FF,3FF,3FF,3FF,3FF,3FF,3FF,3FF,3FF,3FF,3FF,3FF,3FF,3FF,  
Ot30 3FF,3FF,3FF,3FF,3FF,3FF,3FF,3FF,3FF,3FF,3FF,3FF,3FF,3FF,3FF,  
Ot40 3FF,3FF,3FF,3FF,3FF,3FF,3FF,3FF,3FF,3FF,3FF,3FF,3FF,3FF,3FF,  
Ot50 3FF,3FF,3FF,3FF,3FF,3FF,3FF,3FF,3FF,3FF,3FF,3FF,3FF,3FF,3FF,  
Ot60 3FF,3FF,3FF,3FF,3FF,3FF,3FF,3FF,3FF,3FF,3FF,3FF,3FF,3FF,3FF,  
Ot70 3FF,3FF,3FF,3FF,3FF,3FF,3FF,3FF,3FF,3FF,3FF,3FF,3FF,3FF,3FF,  
Ot80 3FF,3FF,3FF,3FF,3FF,3FF,3FF,3FF,3FF,3FF,3FF,3FF,3FF,3FF,3FF,  
Ot90 3FF,3FF,3FF,3FF,3FF,3FF,3FF,3FF,3FF,3FF,3FF,3FF,3FF,3FF,3FF,  
OtA0 3FF,3FF,3FF,3FF,3FF,3FF,3FF,3FF,3FF,3FF,3FF,3FF,3FF,3FF,3FF,  
OtB0 3FF,3FF,3FF,3FF,3FF,3FF,3FF,3FF,3FF,3FF,3FF,3FF,3FF,3FF,3FF,  
OtC0 3FF,3FF,3FF,3FF,3FF,3FF,3FF,3FF,3FF,3FF,3FF,3FF,3FF,3FF,3FF,  
OtD0 3FF,3FF,3FF,3FF,3FF,3FF,3FF,3FF,3FF,3FF,3FF,3FF,3FF,3FF,3FF,  
OtE0 3FF,3FF,3FF,3FF,3FF,3FF,3FF,3FF,3FF,3FF,3FF,3FF,3FF,3FF,3FF,  
OtF0 3FF,3FF,3FF,3FF,3FF,3FF,3FF,3FF,3FF,3FF,3FF,3FF,3FF,3FF,3FF,  
Ot00 3FF,3FF,3FF,3FF,3FF,3FF,3FF,3FF,3FF,3FF,3FF,3FF,3FF,3FF,3FF,  
Ot10 3FF,3FF,3FF,3FF,3FF,3FF,3FF,3FF,3FF,3FF,3FF,3FF,3FF,3FF,3FF,

---

## The Debug Port

---

'S' -

### HARDWARE STATUS

Crosspoint type = 288X288 XPT

Part Number = 1248-1004

Total Power Consumption = 15W

Error Summary - Seating OK - XP Comms OK - XP Power OK - XP Temp OK.

2\_5V voltage = 2509 mV

1\_8V voltage = 1794 mV

1\_2V voltage = 1196 mV

XPT Alarms = 03

0 Chipcode = 0E

1 Globcfg = 18

0 Incfg = 2

1 Otcfg = 20

1 TempA = 66

1 TempB = 66

*(Low Active Temp 0x01 and Power 0x02 Alarms)*

*(Chip Revision, Should be 0x0E)*

*(Global CFG, Should be 0x18)*

*(Input CFG, Should be 0x02)*

*(Out CFG, Should be 0x20)*

*(Upper Corners temp, Alarms at 0xBB)*

*(Lower Corners temp, Alarms at 0xBB*

*6 = < 80 deg C.*

*7 = < 90 deg C.*

*8 = <100 deg C.*

*9 = <110 deg C.*

*A = <120 deg C.*

*B = <130 deg C.)*

---

## 1242-1 Crosspoint Card Diagnostic Information

This serial port connection returns data for just the crosspoint card. It is useful to diagnose error codes reported by the crosspoint, and to determine status. Pressing the space bar will show you a list of available commands. Below is a description of the status reported. The text in italics is an explanation. This list is based on the current SW version, V1.00

```
\V' -
*****
          Utah Scientific Inc.
Utah-400-144 Routing System Monitor, Rev. 1.00
*****

'M' -
FPGA MEMORY STATUS
Level Switch = 03           (Level Switch, Should Match FCM)
Offset Switch = 00        (Offset Switch, Should match FCM)
MX Active?  ->  No.       (MX Activity)
Seating Register = 00     (Seating register, should be 0)
Slot ID Register = 00     (Slot ID, 0x00 or 0x01)
Primary / ID Reg = 54     (MX Device ID, 0x54)
Monitor Matrix  = 79      (Monitor Matrix Selection)
FPGA Rev = 1.02           (FPGA Code Revision)
User Switch = 00 | 00     (SG User Sw Settings)

'S' -
HARDWARE STATUS
Crosspoint type = 144X144 XPT
Part Number = 1242-10AA
Total Power Consumption = 96W
2_5V voltage = 2496 mV
1_8V voltage = 1807 mV
1_2V voltage = 1183 mV
Crosspoint Readback
XP1 = 05C0                (Crosspoint Revision and Chipcode)
XP Enable Reg (good = 01) = 01

'R'
ROUTER STATUS
Ot00 000,000,000,000,000,000,000,000,000,000,000,000,000,000,000,000,
Ot10 000,000,000,000,000,000,000,000,000,000,000,000,000,000,000,000,
Ot20 000,000,000,000,000,000,000,000,000,000,000,000,000,000,000,000,
Ot30 000,000,000,000,000,000,000,000,000,000,000,000,000,000,000,000,
Ot40 000,000,000,000,000,000,000,000,000,000,000,000,000,000,000,000,
Ot50 000,000,000,000,000,000,000,000,000,000,000,000,000,000,000,000,
Ot60 000,000,000,000,000,000,000,000,000,000,000,000,000,000,000,000,
Ot70 000,000,000,000,000,000,000,000,000,000,000,000,000,000,000,000,
Ot80 000,000,000,000,000,000,000,000,000,000,000,000,000,000,000,000,
```

## SDI IO Card Diagnostic Information

This serial port connection returns data for just the IO card. It is useful to diagnose error codes reported by the card, and to determine status. Pressing the space bar will show you a list of available commands. Below is a description of the status reported. The text in italics is an explanation. This list is based on the current SW version, V2.01

```
`V' -
.....
      Utah Scientific Inc.
.....
      UT400-528 IO CD Monitor R2.1
.....
```

```
`S' -
121229-1 Input Card or 121234-1 Fiber Input Card
STATUS REPORT
Pres-Lock Det = 0000      (Indicates Signal Presence, FF0F, is all 12 signals on)
Power Used    = 1 W.      (Indicates power used by the card)
Board Temp    = 15 C.     (Indicates board temperature)
Board PN      = 1229-1005 (Part Number)
Board SN      = 1219      (Serial Number)
Build Date    = 08/26/0B (Build Date)
Slot Address  = 05        (Slot Address, 0-7)
Board Type    = SDI Input (Board Type)
```

```
ONLY For 121234 -
SFP Module ID = 00 | 00 | FF | 47 | 47 | 47 (Non FF indicates module installed)
```

```
121230-1 Output Card or 121235-1 Fiber Output Card
```

```
STATUS REPORT
Pres-Lock Det = 0000      (Indicates Signal Presence, FF0F, is all 12 signals on)
Power Used    = 1 W.      (Indicates power used by the card)
Board Temp    = 15 C.     (Indicates board temperature)
Board PN      = 1229-1005 (Part Number)
Board SN      = 1219      (Serial Number)
Build Date    = 08/26/0B (Build Date)
Slot Address  = 05        (Slot Address, 0-7)
Board Type    = SDI Input (Board Type)
Semaphore     = AB        (Local CPLD Semaphore)
Version       = 01        (Local PLD Version)
Select Reg 1-4 = 00        (Value of out 1-4 select register)
Select Reg 5-8 = 00        (Value of out 5-8 select register)
Select Reg 9-12 = 00       (Value of out 9-12 select register)
Enable Reg 1-8 = FF        (Value of out 1-8 enable register)
Enable Reg 9-12 = FF       (Value of out 9-12 enable register)
```

```
Only For 121235 -
SFP Module ID = 00 | 00 | FF | 47 | 47 | 47 (Non FF indicates module installed)
```



---

`F' -

121234-1 Input Card  
Fiber Status

Module 1 installed. PRESA = 40 - PRESB = 40 - AlarmA = 00 - AlarmB = 00 - Change = 00  
Module 2 installed. PRESA = 40 - PRESB = 40 - AlarmA = 00 - AlarmB = 00 - Change = 00  
Module 3 not installed.  
Module 4 installed. PRESA = 40 - PRESB = 40 - AlarmA = 02 - AlarmB = 02 - Change = 00  
Module 5 installed. PRESA = 40 - PRESB = 40 - AlarmA = 00 - AlarmB = 00 - Change = 00  
Module 6 installed. PRESA = 40 - PRESB = 40 - AlarmA = 00 - AlarmB = 02 - Change = 00

121235-1 Output Card

Module 1 installed. PWRA = 0000 - PWRB = 0000 - AlarmA = 00 - AlarmB = 00  
Module 2 installed. PWRA = 0000 - PWRB = 0000 - AlarmA = 00 - AlarmB = 00  
Module 3 installed. PWRA = 0000 - PWRB = 0000 - AlarmA = 00 - AlarmB = 00  
Module 4 installed. PWRA = 0000 - PWRB = 0000 - AlarmA = 00 - AlarmB = 00  
Module 5 installed. PWRA = 0000 - PWRB = 0000 - AlarmA = 00 - AlarmB = 00  
Module 6 installed. PWRA = 0000 - PWRB = 0000 - AlarmA = 00 - AlarmB = 00

## AES IO Card Diagnostic Information

TBD

---

---

## 121320-1/2 Triple MADI IO card Diagnostic Information

This serial port connection returns data for just the IO card. It is useful to diagnose error codes reported by the card, and to determine status. Pressing the space bar will show you a list of available commands. Below is a description of the status reported. The text in italics is an explanation. This list is based on the current SW version, V3.00

### 121320-2 Output Card

'S'-

#### STATUS REPORT

Pres-Lock Det = 0000 *(Indicates Signal Presence, 0780 if healthy)*  
Power Used = 1 W. *(Indicates power used by the card)*  
Board Temp = 15 C. *(Indicates board temperature)*  
Board PN = 1320-1001 *(Part Number)*  
Board SN = 0103 *(Serial Number)*  
Build Date = 08/26/0B *(Build Date)*  
Slot Address = 05 *(Slot Address, 0-7)*  
Config - Output Card, Dser Lock = 01 *(Indicates Lock to TDM from crosspoint)*  
Mux Selection = 01 *(Indicates which crosspoint signal is from)*

### 121320-1 Input Card

'S' -

#### STATUS REPORT

Pres-Lock Det = 0000 *(Indicates Signal Presence, 0700 if healthy)*  
Power Used = 1 W. *(Indicates power used by the card)*  
Board Temp = 15 C. *(Indicates board temperature)*  
Board PN = 1320-1001 *(Part Number)*  
Board SN = 0103 *(Serial Number)*  
Build Date = 08/26/0B *(Build Date)*  
Slot Address = 05 *(Slot Address, 0-7)*  
Config - Input Card, In 1 Copper, In 2 Fiber, In 3 Copper. *(Details Input Mode)*  
CH1 Stat, Err - C3,01 *(Status, Error Bit Report)*  
CH2 Stat, Err - C3,01 *(Status, Error Bit Report)*  
CH3 Stat, Err - C3,01 *(Status, Error Bit Report)*

#### Status, Error Bit Table -

Status Bit Number	Description	Error Bit Number	Description
0x01	VCO Locked	0x01	MADI Rx_Ready
0x02	Sample Rate MD 0	0x02	0
0x04	Sample Rate MD 1	0x04	0
0x08	Sample Rate MD 2	0x08	MADI Error
0x10	0	0x10	RX_Parity_Error
0x20	0	0x20	RX_Framing_Error
0x40	MADI RX_Ready	0x40	RX_FIFO_Underflow
0x80	MADI Valid	0x80	RX_FIFO_Overflow

'I' -

Increment internal Monitor Matrix Port

## Embedding SDI Output Card (121293-1/2) Diagnostic Information

This serial port connection returns data for just the IO card. It is useful to diagnose error codes reported by the card, and to determine status. Pressing the space bar will show you a list of available commands. Below is a description of the status reported. The text in italics is an explanation. This list is based on the current SW version, V3.00.

```
'V' -
.....
      Utah Scientific Inc.
      UT400-528 EMB-DEEMB CD Monitor R1.0
.....

'I' -
      Increment internal Monitor Matrix Port

'S' -
STATUS REPORT
Pres-Lock Det  = FF80      (Indicates Signal Presenceas 1230 bd, 80 bit is TDM)
Power Used     = 16 W.     (Board Power Used)
Board Temp     = 28 C.     (Board Temperature)
Board PN       = 1293      (Board Part Number)
Board REV      = A0        (Board Revision)
Slot Address   = 03        (Slot Address)
Error Register = 00        (Error Register)
Board Type     = Embedder Output
SPH-Version : DE1= 55aa-10, DE2= 55aa-10, DE3=55aa-10, AP= 55aa-10
(Semaphore and revision of the 4 on board FPGA devices)

VLock Regs Ins 00-03 - >E2|E2|E2|E2      (Vid Std, See table)
VERR Regs Ins 00-03 - >11|00|08|00      (Vid CRC Error count)
ALock Regs Ins 00-03 - >FF|FF|FF|FF      (Audio Lock Regs)
DE_EN Regs Ins 00-03 - >11|41|08|00      (Embed Enable Register)
VLock Regs Ins 04-07 - >E2|E0|E2|E2      Repeated for the other channels
VERR Regs Ins 04-07 - >06|58|00|00      "
ALock Regs Ins 04-07 - >FF|FF|FF|FF      "
DE_EN Regs Ins 04-07 - >00|00|00|00      "
VLock Regs Ins 08-11 - >00|00|00|00      "
VERR Regs Ins 08-11 - >00|00|00|00      "
ALock Regs Ins 08-11 - >00|00|00|00      "
DE_EN Regs Ins 08-11 - >0D|00|00|00      "
APROC MSEL Address = 00      (Internal Monitor Matrix Selection)
TDM DSER Stat, Sel = 0301    (Indicates lock to and which XPT for the TDM Input)
```

---

---

## Dis Embedding SDI Input Card (121292-1) Diagnostic Information

This serial port connection returns data for just the IO card. It is useful to diagnose error codes reported by the card, and to determine status. Pressing the space bar will show you a list of available commands. Below is a description of the status reported. The text in italics is an explanation. This list is based on the current SW version, V3.00.

```
`V' -
.....
      Utah Scientific Inc.
      UT400-528 EMB-DEEMB CD Monitor R1.0
.....
```

```
`I' -
      Increment internal Monitor Matrix Port
```

```
`S' -
STATUS REPORT
Pres-Lock Det = FF80      (Indicates Signal Presence as 1229 board)
Power Used    = 16 W.    (Board Power Used)
Board Temp    = 28 C.    (Board Temperature)
Board PN      = 1292     (Board Part Number)
Board REV     = A0       (Board Revision)
Slot Address  = 03       (Slot Address)
Error Register = 00      (Error Register)
Board Type    = Embedder Output
SPH-Version : DE1= 55aa-10, DE2= 55aa-10, DE3=55aa-10, AP= 55aa-10
(Semaphore and revision of the 4 on board FPGA devices)
```

```
VLock Regs Ins 00-03 - >E2|E2|E2|E2      (Vid Std, See table)
VERR Regs Ins 00-03 - >11|00|08|00      (Vid CRC Error count)
AERR Regs Ins 00-03 - >00|00|00|00      (AES Error Count)
AFIFO Regs Ins 00-03 - >0F|00|00|00      (Audio FIFO OK Registers)
VLock Regs Ins 04-07 - >E2|E0|E2|E2      Repeated for the other channels
VERR Regs Ins 04-07 - >06|58|00|00      "
AERR Regs Ins 00-03 - >00|00|00|00      "
AFIFO Regs Ins 00-03 - >0F|00|00|00      "
VLock Regs Ins 08-11 - >00|00|00|00      "
VERR Regs Ins 08-11 - >00|00|00|00      "
AERR Regs Ins 00-03 - >00|00|00|00      "
AFIFO Regs Ins 00-03 - >0F|00|00|00      "
APROC MSEL Address = 00      (Internal Monitor Matrix Selection)
AES pres Regs = FF|00|00|00|00|FF|FF|FF|FF|00|00|00
(AES Presence info, Qne entry per video signal, AES Pairs)
```

### 121337-1 72x72 Crosspoint card Diagnostic Interface

This serial port connection returns data for just the crosspoint card. It is useful to diagnose error codes reported by the crosspoint, and to determine status. Pressing the space bar will show you a list of available commands. Below is a description of the status reported. The text in italics is an explanation. This list is based on the current SW version, V1.00

'S' -

#### *Power Supply Status -*

PS1 reg = FF, temp = 1D. PS2 reg = FF, temp = 25. (PS1 and PS2 status info)

Monitor Matrix = 0(Monitor Matrix Selection)

Ethernet ID = 0x61(ID Of the local Ethernet Switch)

Audio Crosspoint 1 PN = 1338, Audio Crosspoint 2 PN = FFFF. (Audio Crosspoint PN)

'G' -

Reading Scangate part.

Part Number = 1337-10( Part Number of local crosspoint)

USW = 01, SN=0103 ( User switch and Serial Numbers)

MAC Address = '0800:'5B00:'0941(MAC address of this card)

'X' -

Returns the crosspoint switching status

'F' -

Returns various FPGA register details

'I' -

#### IO Card Status Information

IO 0 Part> 1292-10 Rev> 6 Serial> 19.(PN, Rev and SN number of each IO card)

IO 1 Part> 1229-10 Rev> 1 Serial> 121.

IO 2 Part> 1229-10 Rev> 5 Serial> 698.

IO 3 Part> 1229-10 Rev> 1 Serial> 14.

IO 4 Part> 1229-10 Rev> 1 Serial> 114.

IO 5 Part> 1292-10 Rev> 6 Serial> 114.

---

IO 6 Part> 1293-10 Rev> A0 Serial> 155.  
IO 7 Part> 1230-10 Rev> 1 Serial> 123.  
IO 8 Part> 1320-10 Rev> 1 Serial> 17.  
IO 9 Part> 1230-10 Rev> 1 Serial> 121.  
IO 10 Part> 1230-10 Rev> B0 Serial> 2151.  
IO 11 Part> 1230-10 Rev> 1 Serial> 18.

### **121338-1 72x72 Audio Crosspoint card Diagnostic Interface**

This serial port connection returns data for just the crosspoint card. It is useful to diagnose error codes reported by the crosspoint, and to determine status. Pressing the space bar will show you a list of available commands. Below is a description of the status reported. The text in italics is an explanation. This list is based on the current SW version, V1.00

'S' –

FPGA Version = 1.2  
Semaphore = 1234  
Dipswitch = 0  
Audio Reference = OK.  
Slot = Primary.  
Audio Xpoint = OK.

'G' -

AXP Part Number = 1338-10, Rev 9 (PN and rev of crosspoint)  
AXP Serial Number = 100(SN of Crosspoint)  
TBC Part Number = 1285-10, Rev 1(PN and Rev of Timebase module)  
TBC Serial Number = 102(SN of Timebase module)  
TBC Ref Stat = 6(Timebase reference status, should be 6)

'X' –

*Audio Crosspoint Status -*

Semaphore = 136C (Semaphore from AXPT)

Lock Stat = 41 (Which cards are feeding AXPT)

Version = 500 (Version of AXPT Firmware)

ACLK Stat = 3 (Audio Clock Status)

Out 0 = FFF (Inputs for first 12 outputs)

Out 1 = FFF

Out 2 = FFF

Out 3 = FFF

Out 4 = FFF

Out 5 = FFF

Out 6 = FFF

Out 7 = FFF

Out 8 = FFF

Out 9 = FFF

Out 10 = FFF

Out 11 = FFF

'M' –

MX Active ? -> 1(MX Active indicator (will fluctuate))

MX Level -> 0(MX Dipswitch Setting)

MX Enabled -> 1(MX Enabled?)

'A' – MADI status

M1 Format -> Copper(Input Format)

M2 Format -> Copper

M1 Input UN-Locked(M1 Status)



---

---

M1 Error Register = 80

M1 VCO Count = 40

M1 VCO Divisor = F

M2 Input Locked(M2 Status)

M2 Error Register = 1

M2 VCO Count = 40

M2 VCO Divisor = F

---

**The Debug Port**

---

*The UT4-528 Digital Audio  
Breakout Panel*

---

This Appendix contains the following:

Scope .....	C-2
The AES Breakout Panel Kit .....	C-2
Description of the AES Breakout Panel .....	C-3
Analog Rear Panels Connected to Breakout Panel .....	C-4
AES Balanced Rear Panels Connected to Breakout Panel .....	C-5
Installation of the AES Breakout Panel .....	C-7
Label Instructions for the Utah-400 Breakout Panel .....	C-9
Scope .....	C-9
Application .....	C-9

---

### *Scope*

This Appendix applies only to the installation of the AES Digital Audio Break Out Panel. The Breakout Panel and Cables are pre-tested at the factory before shipment and do not need any modifications. The customer is responsible for wiring the Sources and Destinations to each panel.

---

### *The AES Breakout Panel Kit*

Each breakout panel kit ordered from Utah Scientific (part # 140023-0004) is shipped with the following items:

- (1) Breakout Panel
- (3) 3 foot 37 pin to 26 pin BOP cables (part number 140000-85)
- (1) field wiring kit, which includes nine tension grip connectors.

---

**Description of the AES Breakout Panel**

---

---

*Description of the AES Breakout Panel*

---

The AES Breakout Panel is designed to simplify the installation of the UT4-528 Balanced Digital Audio Routing System. The breakout cables are pre-wired to connect directly between the UT4-528 Balanced Digital Audio backplane and the breakout panel. Only a screwdriver is needed for this installation. The Breakout panels are generic, and may be used for either sources or destinations. Each panel is silk screened from 0 on the left, to 71 on the right. Each labeled block on the rear of the panel corresponds to the labeled block on the front of the panel.

The Breakout Panel contains connectors that are in groups of eight differential pairs. The UTAH-400 Series 2 audio balanced rear panels contain connectors that are in groups of 12 differential pairs. Two of the UTAH-400 Series 2 audio connectors are connected to three of the Breakout Panel connectors through the BOP cables (140000-85).



**FIGURE C-1.**

---

### Analog Rear Panels Connected to Breakout Panel

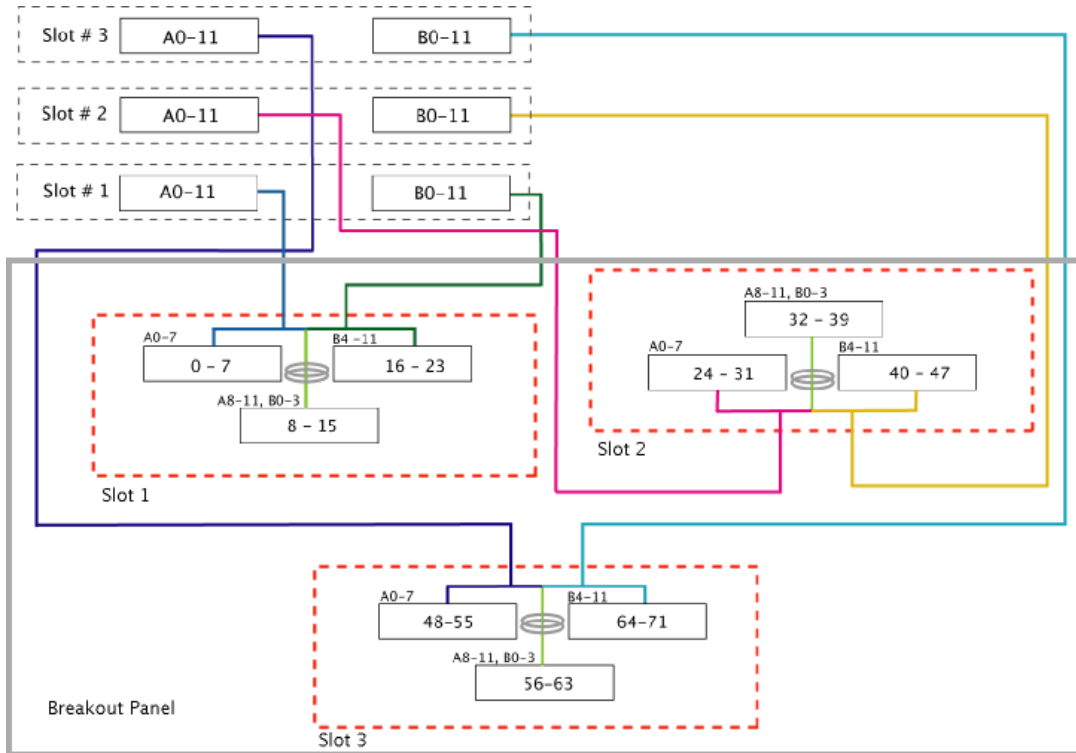

FIGURE C-2.

---

Description of the AES Breakout Panel

---

**AES Balanced Rear Panels Connected to Breakout Panel**

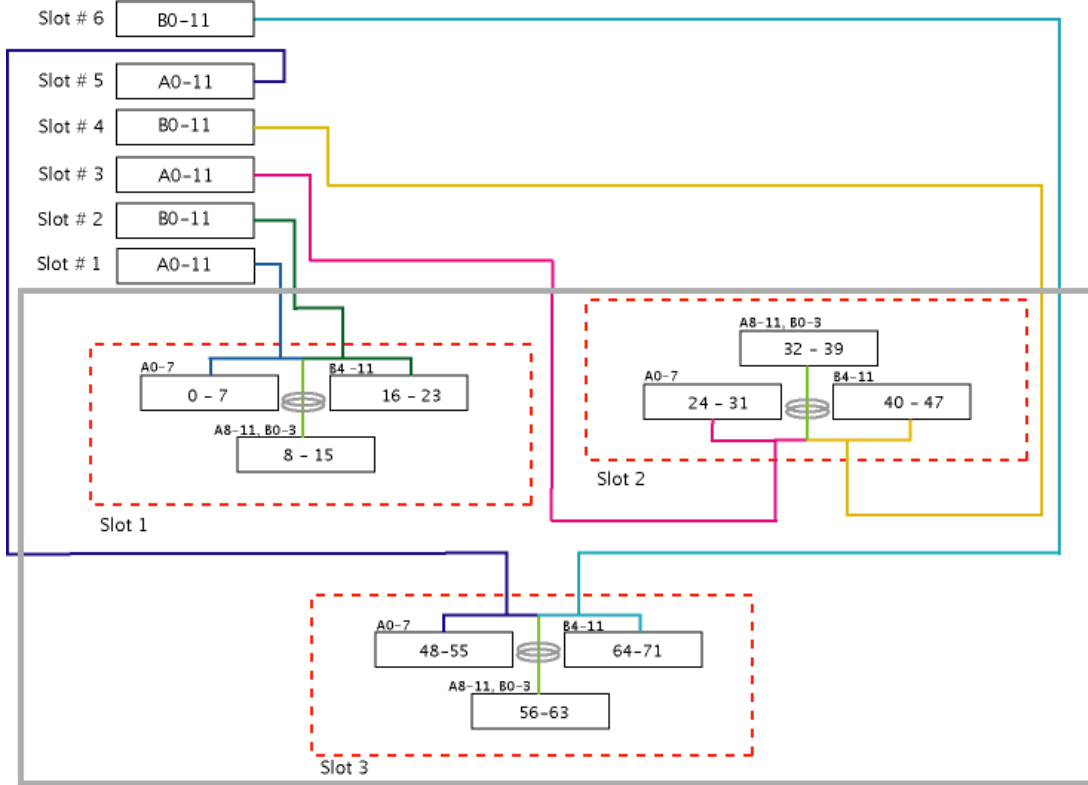

FIGURE C-3.

---

## The UT4-528 Digital Audio Breakout Panel

---

### Connection Examples

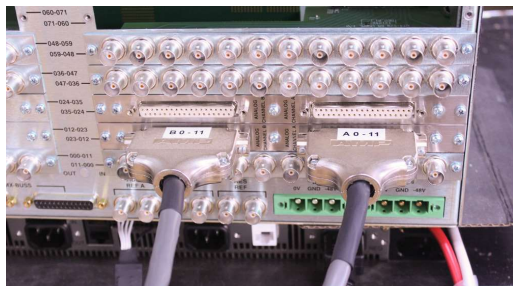

**FIGURE C-4. Analog inputs**

---



**FIGURE C-5. BOP connections**

---



**FIGURE C-6. Digital outputs**

---



---

## *Installation of the AES Breakout Panel*

To install the Breakout Panel:

1. Install the BOP at the desired location on the rack frame. (Within three feet of the Utah-400 Digital Audio Backplane.)
2. Install the cables from the UT4-528 input or output to the matching BOP backplane input or output. Continue in the same manner for each input or output for the remaining eight blocks on the breakout panel.
3. Unpack the Field Wiring Kit and connect the required sources or destinations to each of the tension clamp connectors. Refer to Figure C-8 on page C -8, for wiring each tension clamp connector.

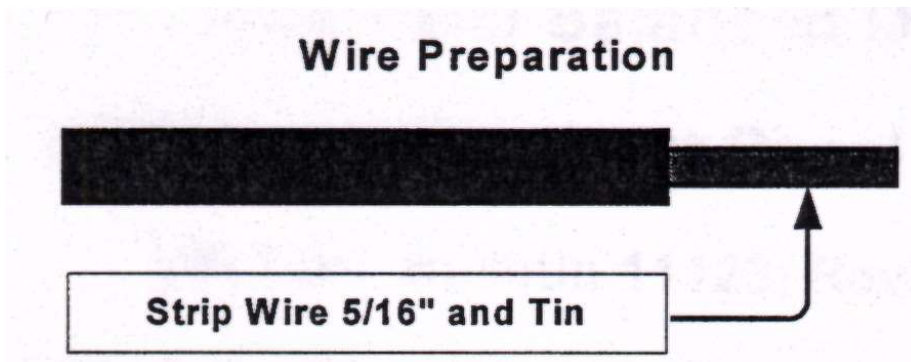

**FIGURE C-7. Wire Prep**

---

1. Insert the small screwdriver into the rectangular holes to release the wire clamp.
2. Insert the wire into the round hold above or below the rectangular slot.
3. While holding the wire in the hole, pull out the screwdriver (inserted in Step 1).
4. Tug on the inserted wire to verify that it is properly clamped.
5. Repeat for the entire connector.

*Note: Wiring is the same for each sequential block following 0 - 7. Example; 8 - 15, 16 - 23, etc. **Failure to follow these steps will result in loose or no connections, and the wire may fall out of the hole.***

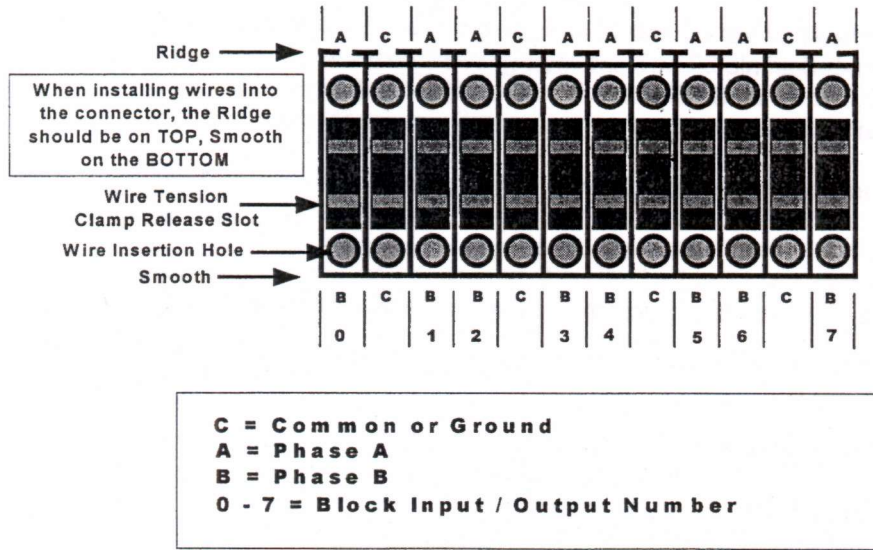

FIGURE C-8. Tension Clamp Connector (viewed from the back)

---

## *Label Instructions for the Utah-400 Breakout Panel*

### **Scope**

This document applies to the label installation on the Utah-400 Breakout Panel. Labels included in this kit include the 54450-1035 (Input Labels 000 through 287) and 54450-1036 (Output Labels 000 through 287).

Section Two of this document shows the proper wiring techniques to use on the Breakout Panel.

### **Application**

The labels provided for the Utah-400 Breakout Panels are to be applied over the silk-screened blocks (00 – 71) below the front and back connectors on each panel. Each label sheet has two labels for each input / output range (e.g. 000 – 007) for this application.

Each label sheet will consecutively label up to four breakout panels from Inputs 000 through 287 and four breakout panels from Outputs 000 through 287.

If you do not receive enough labels for your particular application, contact Utah Scientifics' Technical Services at 1-800-447-7204 for additional labels.

The illustration below shows the proper application of the labels on the breakout panel.

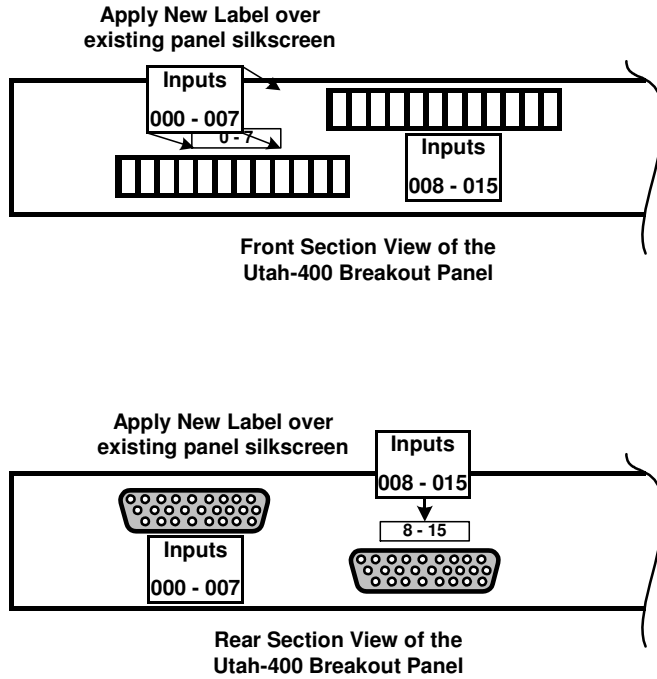

**FIGURE C-9. Breakout Panel Label Application**

---

## Numerics

0V 2-36  
10 X 10 switching matrix 1-7  
12 Port TDM Crosspoint Submodule 4-49  
121288-1 4-53  
121289-1 4-59  
121292-1 4-30  
121293-1/2 4-34  
121295-1 4-49  
121295-1 TDM Audio Crosspoint Module 2-41  
121320-1/2 4-44  
121323-1 4-51  
121325-1 4-72  
121326-1 4-66  
121332-1 SDI Module 4-80  
121337-1 4-76  
121338-1 4-78  
121395-1 4-82  
121396-1 4-88  
121400-1 4-106  
121401-1 4-116  
121405-1 4-39  
2 MIHI Video + MADI Input Card 4-101  
288 Module Array 3-7  
288x288 Crosspoint Card 4-20  
-48V 2-36  
528 Configuration 1-14  
528 Frame TDM Crosspoint Carrier 4-51  
528 Module Array 3-8  
528 Systems 2-2  
72x72  
    audio crosspoint card 4-78  
    crosspoint card 4-76  
72x72 AV Router 2-40

## A

Abbreviations 1-4  
Additional Functions  
    MOHO Video + MADI Output Card 4-97  
Advanced Input Card 4-82  
Advanced Input Card – 121395-1 4-82  
Advanced Output Card – 121396-1 4-88  
AES Balanced Rear C-5  
AES Breakout Panel C-2  
    description C-3  
    installation C-7  
AES reference cabling 2-24  
AES reference signal 2-24  
Air Dam

    removal and maintenance 3-13  
Alarm Indication 3-10  
alarm indicators  
    fan 3-14  
alarm specifications A-6  
alarms  
    system controller 5-8  
Analog inputs C-6  
Analog Rear Panels C-4  
Audio Crosspoint  
    card diagnostic interface B-23  
Audio Crosspoint Card – 121338-1 4-78  
Audio Crosspoint Status B-24  
audio subsystem  
    troubleshooting table 5-5  
AV Router Component  
    72x72 crosspoint card 4-76

## B

basic system operation 3-10  
BOP connections C-6  
breakaway takes 1-6  
Breakout Panel C-1

## C

cable connection recommendations 2-31  
cable installation  
    digital audio input and output 2-33  
card ejectors 3-12  
card removal and replacement 3-12  
Chassis Types 3-4  
Circuit Description 4-5  
    2 MIHI Video + MADI Input Card 4-101  
    72x72 crosspoint card 4-77  
    Advanced Input Card 4-83  
    SMPTE 2022 Receiver 4-106  
    SMPTE 2022 Transmitter 4-116  
    UT400 Series 2 12 Port TDM Crosspoint  
        Submodule 4-49  
    UT400 Series 2 528 Frame TDM Crosspoint  
        Carrier 4-51  
    UT400 Series 2 Embedding SDI Output Card 4-40  
    UT400 Series 2 Triple Port MADI IO Card 4-44  
    UT4-528 Digital Audio Analog to Digital 4-72  
    UT4-528 Standard Digital Audio Input with TDM  
        Board 4-53  
    UT4-528 Standard Digital Audio Output with TDM  
        Board 4-59  
video crosspoint board 4-18

---

Configuration and Operation 3-1  
connector suppliers A-9  
control panel  
    troubleshooting table 5-9  
control specifications A-6  
control subsystem troubleshooting table 5-7  
Controls And Indicators  
    2 MIHI Video + MADI Input Card 4-102  
    72x72 crosspoint card 4-77  
    Advanced Input Card 4-86  
    Audio Crosspoint Card – 121338-1 4-79  
    MOHO Video + MADI Output Card 4-97  
    UT400 Series 2 12 Port TDM Crosspoint  
        Submodule 4-50  
    UT400 Series 2 528 Frame TDM Crosspoint  
        Carrier 4-52  
    UT400 Series 2 Embedding SDI Output Card 4-41  
    UT400 Series 2 Triple Port MADI IO Card 4-45  
Controls and Indicators  
    SMPTE 2022 Receiver 4-108  
    SMPTE 2022 Transmitter 4-117  
    UT4-528 Digital Audio Analog to Digital (ADC) 4-  
        73  
    UT4-528 Standard Digital Audio Input with TDM  
        Board 4-54  
    UT4-528 Standard Digital Audio Output with TDM  
        Board 4-60  
    video crosspoint board 4-18  
Conventions 1-3  
crosspoint card  
    removal and replacement 3-12  
Crosspoint Card - 121337-1 4-76  
Crosspoint Cards Maintenance 3-11

## D

DC Connectivity 2-36, 2-39  
DC power specifications A-2  
Debug  
    port C-1  
Definitions  
    control panel 1-5  
    destination 1-5  
    display 1-5  
    high definition 1-6  
    hot swappable 1-5  
    monitor 1-6  
    output 1-5  
    serial digital 1-6  
    signal level 1-5

    source 1-5  
Delay Considerations 1-22  
Digital Audio Analog to Digital (ADC) Input with  
    TDM Board 4-72  
Digital Audio Digital to Analog (DAC) Output with  
    TDM Board 4-66  
digital audio specifications A-4  
Digital outputs C-6  
Digital Video A-3  
Dis-Embedding SDI Fiber Input Card 4-26  
Dis-Embedding SDI Input Card 4-30

## E

Embedding SDI Fiber Output Card 4-39  
Embedding SDI Output Card 4-34  
equipment installation 2-21  
Ethernet and RS-422 Connection 3-11  
Ethernet Port 2-29  
External Power Supply 3-15

## F

Fan Service 3-14  
fan service 3-13  
Fiber Interface 4-11, 4-13  
frame connection  
    SC-3 to Utah-400 2-22  
Frame Controller 4-13

## G

GPIO Port 2-30  
Ground 2-36

## H

hardware checkout 2-39  
Hardware Installation 2-1

## I

input power specifications A-2  
Insert 1-3  
installation  
    audio input and output recommendations 2-33  
    video input and output 2-31  
Installing Physical Equipment 2-16  
Interface board (midplane)  
    general description 4-125  
Introduction 1-1

## K

K70 Network Processor Menu



SMPTE 2022 Transmitter 4-120

## L

LED Indications  
power supplies 4-128  
Local Monitoring Processor Menu  
SMPTE 2022 Receiver 4-111  
SMPTE 2022 Transmitter 4-120

## M

MADI  
MOHO Video + MADI Output Card 4-98  
UT400 Series 2 Triple Port IO card 4-44  
MADI Circuitry  
MOHO Video + MADI Output Card 4-96  
MADI Input Card 4-101  
MADI Output Card 4-95  
matrix backplane 2-31  
MOHO Video + MADI Output Card 4-95  
Monitor Matrix Module 4-15  
Monitor Port Usage  
72x72 crosspoint card 4-77  
Audio Crosspoint Card – 121338-1 4-79  
Multi-rate 4-5  
Multirate Differential Pair Output Card 4-9  
Multirate Fiber Input Card 4-7  
Multi-rate Output card 4-5  
Multi-rate SDI Input Card 4-3  
MX-Bus 1-3  
MX-Bus cable installation 2-21

## O

Offset Switch 2-27  
Operational Modes  
Advanced Input Card 4-86  
Operator Actions 1-3  
Overview  
72x72 4-76

## P

physical specifications A-7  
power connections 2-34  
power subsystem troubleshooting table 5-6  
Power Supplies  
Audio Crosspoint Card – 121338-1 4-94  
MOHO Video + MADI Output Card 4-96  
UT400 Series 2 12 Port TDM Crosspoint  
Submodule 4-50  
power supplies 4-126

Power Supply 3-15  
power supply alarms 5-6  
Power Supply Status  
crosspoint card diagnostic interface B-22  
Pre Power-Up Checks 2-37

## R

rack frame layout 2-17  
rack frame mounting 2-17  
Rear Panel Connections  
MOHO Video + MADI Output Card 4-99  
SMPTE 2022 Receiver 4-109  
SMPTE 2022 Transmitter 4-118  
UT400 Series 2 Embedding SDI Output Card 4-43  
UT400 Series 2 Triple Port MADI IO Card 4-47  
UT4-528 Digital Audio Analog to Digital (ADC) 4-75  
UT4-528 Standard Digital Audio Input with TDM  
Board 4-56  
UT4-528 Standard Digital Audio Output with TDM  
Board 4-61  
Rear Panel Interconnect  
72x72 2-41  
Rear Panel Layout  
UT4-528 Standard Digital Audio Input with TDM  
Board 4-56  
reference specifications A-5  
regulatory specifications A-8  
Router Power supplies 4-127  
routing switcher basics 1-6

## S

sample configurations 1-12  
SC-4 Control 3-2  
SD video input 4-3  
SDI Module 4-80  
Serial Diagnostic Port Commands  
2 MIHI Video + MADI Input Card 4-104  
Advanced Input Card 4-86  
MOHO Video + MADI Output Card 4-99  
UT4-528 Digital Audio Analog to Digital (ADC) 4-75  
Serial Port 2-28  
Shuffling versus Routing 1-23  
signal level  
definition 1-8  
signal level setup 2-25  
SMPTE 2022 Processor Menu  
SMPTE 2022 Transmitter 4-120

---

---

SMPTE 2022 Receiver 4-106  
SMPTE 2022 Transmitter 4-116  
Specification Detail 4-12  
Specifications A-1  
  2 MIHI Video + MADI Input Card 4-103  
  Advanced Input Card 4-87  
  alarms A-6  
  connector suppliers A-9  
  control A-6  
  input and DC power A-2  
  MOHO Video + MADI Output Card 4-98  
  physical A-7  
  reference A-5  
  regulatory A-8  
  SMPTE 2022 Transmitter 4-124  
  UT400 Series 2 Embedding SDI Output Card 4-42  
  UT400 Series 2 Triple Port MADI IO Card 4-47  
  UT4-528 Standard Digital Audio Input with TDM Board 4-58  
  UT4-528 Standard Digital Audio Output with TDM Board 4-64  
Standard Digital Audio Input with TDM Board 4-53  
Standard Digital Audio Output with TDM Board 4-59  
Subsystem Level Troubleshooting 5-2  
Supported Signal Types 1-22  
Switch 1-3  
switching matrix 1-7  
system configurations 1-12  
System Control Functionality  
  72x72 3-5  
system controller alarms 5-8  
System Layout  
  72x72 4-94  
system weight 2-2, 2-4

## T

TDM Enabled IO Cards 1-22  
Tension Clamp Connector C-8  
terminal block 2-36  
Terminal Interface  
  SMPTE 2022 Receiver 4-110  
  SMPTE 2022 Transmitter 4-119  
Terms 1-5  
Troubleshooting 5-1  
troubleshooting chart 5-2  
troubleshooting tables  
  audio subsystem 5-5  
  control panel 5-9  
  control subsystem 5-7

main 5-3  
power subsystem 5-6  
video subsystem 5-4

## U

Unbalanced Digital Audio Input & Output  
  installation 2-31  
  unpacking 2-2, 2-3  
UT400 144x144 Crosspoint Card 4-23  
UT-400 Embedded Signal Processing Functionality 1-20  
UT4-528 Digital Audio Analog to Digital 4-72  
Utah 400 SC-4 Control 3-2  
Utah-400 Breakout Panel  
  label instruction C-9  
Utah-400 Components 4-1  
Utah-400 routing matrix 1-9

## V

Video  
  MOHO Video + MADI Output Card 4-98  
Video Circuitry  
  MOHO Video + MADI Output Card 4-96  
Video Crosspoint board  
  description 4-17  
Video crosspoint board (redundant) 4-17  
video crosspoint LED's  
  scan data active 4-19  
Video Input 4-1  
Video Output Boards 4-5  
video subsystem  
  troubleshooting table 5-4

## W

Wire Preparation  
  breakout panel C-7

## X

XL Configuration 1-12  
XL Systems  
  carton handling and chassis management 2-4